



THS[®]
THERMOSTYLE



CATALOGUE

PLUMBING AND HEATING
ВОДОПРОВОД И ОТОПЛЕНИЕ

2023

THS Thermostyle е Българска търговска марка, регистрирана от ОНМ със сертификат № 010276855/27.02.2012г.

Всички продукти са произведени при спазване на технологични стандарти, гарантиращи тяхната надеждност. Сертифицирани са в съответствие с националните и европейски изисквания за контрол на качеството.

Широка продуктова гама от 3/8" до 4", включваща богат асортимент от арматура за водопровод и отопление.

Всички продукти с търговска марка **THS Thermostyle** притежават 5 години гаранция, освен продуктите, за които не е посочено друго.

Избирайки търговска марка **THS Thermostyle**, Вие избирате сигурност и качество на справедлива цена.

THS[®]

Thermostyle, EU, Bulgaria, Sofia



THS Thermostyle is a Bulgarian trademark registered by OHIM with a certificate № 010276855 / 27.02.2012.

All products are manufactured in compliance with technology standards to ensure their reliability. Certified in accordance with Bulgarian and European quality control requirements. Wide product range from 3/8" to 4", including a wide assortment of plumbing and heating fittings. All products with the trademark **THS Thermostyle** have a 5-year warranty. Except the products mentioned with a different warranty.

By choosing the **THS Thermostyle** brand you choose security and quality at a competitive price.

СЪДЪРЖАНИЕ: CONTENT:

THS[®]
THERMOSTYLE



ВОДОПРОВОД: PLUMBING:

1-34



ОБОРУДВАНЕ ЗА БАНЯ: BATHROOM EQUIPMENT:

37-64

Месингови спирателни вентили Brass stop valves	1
Месингови сферични кранове Brass ball valves	2
Месингови ъглови кранове Brass angle valves	6
Месингова водопроводна арматура Brass water supply armature	13
Месингови канели Brass bibcocks	17
Месингови хромирани фитинги Brass fittings chrome plated	22
Месингови фитинги Brass fittings	29
Месингови никелирани фитинги Brass fittings nickel plated	32
Месингови холендри и предпазни вентили Brass unions and safety valves	34

Едноръкохваткови месингови смесители Brass mixers single handle	42
- Серии PHILIPOLIS, PLISKA BLACK, PLISKA WHITE Series PHILIPOLIS, PLISKA BLACK, PLISKA WHITE	42
- Серии ZLATOGRAД, NIKOPOL, KALOФER Series ZLATOGRAД, NIKOPOL, KALOФER	43
- Серии SEXAGINTA PRISTA, SERDIKA, SREDEC Series SEXAGINTA PRISTA, SERDIKA, SREDEC	44
- Серии SOFIA, DOROSTOL, ODESSUS Series SOFIA, DOROSTOL, ODESSUS	45
- Серии TERVEL, TAURUS Series TERVEL, TAURUS	46
- Серия BALCHIK Serie BALCHIK	47
- Серия AQUARIUS Serie AQUARIUS	48

Двуръкохваткови месингови смесители Серия ВИТА, ДАЛИЯ и РЕТРО, ИСКЪР, РОСИЦА Brass mixers for bathroom double handle Series: VITA, DALIA and RETRO, ISKAR, ROSITSA	49
-----------------------------------------------------------------------------------------------------------------------------------------------------------------------------	----



ОБОРУДВАНЕ ЗА БАНЯ: BATHROOM EQUIPMENT:

37-64

Едноръкохваткови месингови смесители Серия ROSE Brass mixers for bathroom single handle Series ROSE	37
Едноръкохваткови месингови смесители Серия RAINBOW и аксесоари RAINBOW Brass mixers for bathroom single handle Series ROSE and Accessories RAINBOW	38
Едноръкохваткови месингови смесители Серия BLACKMATT Brass mixers for bathroom single handle Series BLACKMATT	40
Интимен смесител за външен монтаж със затварящ механизъм THS by SEDAL Shataff full set with cartage THS by SEDAL	41

Принадлежности за смесители Accessories for mixers for sinks	54
Шлаухи Shower hoses	61
Сифони Drainers	62
Тефлони и кълчища PTFE and hackled flaxes	64





TMS[®]
THERMOSTYLE



ОТОПЛЕНИЕ:
HEATING:

67-115

Лири за баня Towel radiators for bathroom	67	Арматура за подово отопление Underfloor heating armature	100
- Алюминиеви лири за баня Aluminium radiators for bathroom	67	Принадлежности за колектори Equipment and valves	102
- Електрически алуминиеви лири за баня Electric aluminium radiators for bathroom	71	Месингови фитинги 24 x 19 Brass fittings 24 x 19	103
- Стоманени лири за баня Steel towel radiators for bathroom	73	Разглобяеми фитинги за PEX-AL -PEX тръба Remountable fittings for PEX-AL -PEX pipe	105
Електрически нагреватели Electric heaters	75	Пресфитинги за PEX-AL -PEX тръба Press fittings for PEX-AL -PEX pipe	107
Крепешни елементи и аксесоари за радиатори Fasteners and accessories for radiators	78	Месингови мини сферични кранове Brass mini ball valves	109
Обезвъздушители Air vents and thermostatic heads	80	Колекторни кутии и пожарни табла Boxes for manifolds and cabinets for fire valves	110
Радиаторни комплекти Radiator sets	82	Циркулационни помпи Circulating pumps	111
Радиаторни вентили Radiator valves	91	Термометри, манометри, термоманометри и предпазни вентили Thermometers, manometers, termomanometers and safe valves	112
Термоглави Thermostatic heads	94	Разширителни съдове Extension tanks and pressure control tanks	113
Колектори Manifolds	97	Пакетажи и легенда Packaging and legend	116



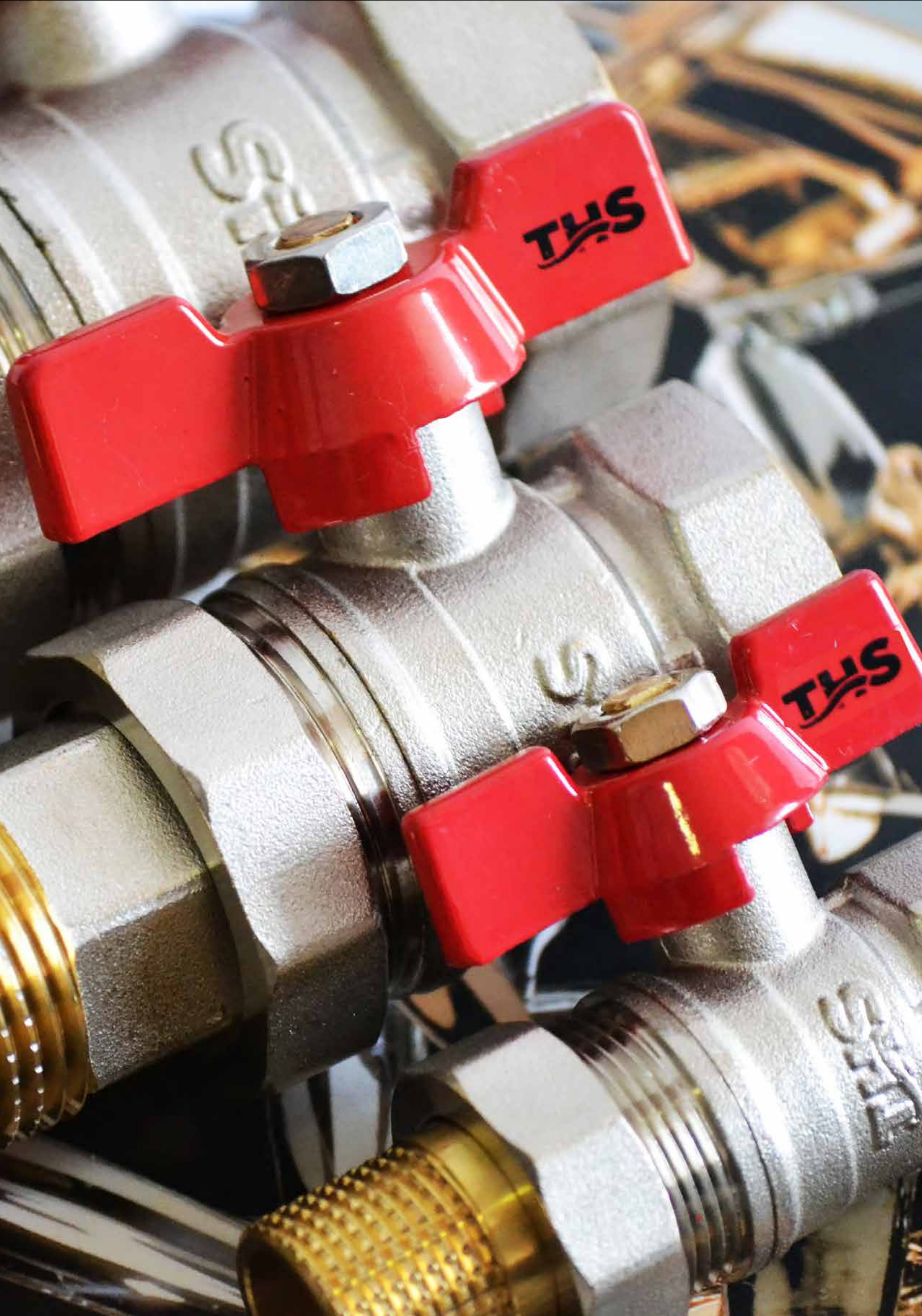

TMS

TMS

TMS

МЕДИНГОВИ СПИРАТЕЛНИ ВЕНТИЛИ BRASS STOP VALVES

СПИРАТЕЛЕН ВЕНТИЛ МЕДИНГ BRASS STOP VALVE



Размер Dimension	Арт. № Item №	Баркод Barcode			
1/2"	40001	3800154007811	16/192		
3/4"	40002	3800154007828	10/120		
1"	40008	3800154018961	6/72		

СПИРАТЕЛЕН ВЕНТИЛ С ИЗПУСКАТЕЛ МЕДИНГ BRASS STOP VALVE WITH AIRVENT



Размер Dimension	Арт. № Item №	Баркод Barcode			
1/2"	40003	3800154007835	8/96		
3/4"	40004	3800154007842	6/72		

ЗАТВАРЯЩ МЕХАНИЗЪМ ЗА СПИРАТЕЛЕН ВЕНТИЛ МЕДИНГ BRASS CARTAGE FOR BRASS STOP VALVE



Размер Dimension	Арт. № Item №	Баркод Barcode			
за спирателен вентил 1/2" for brass stop valve 1/2"	40005	3800154007859	20/240		
за спирателен вентил 3/4" for brass stop valve 3/4"	40006	3800154007866	18/216		
за спирателен вентил 1" for brass stop valve 1"	40009	3800154018978	10/120		



TMS[®]
THERMOSTYLE



МЕДИНГОВИ СФЕРИЧНИ КРАНОВЕ

BRASS BALL VALVES

СФЕРИЧЕН КРАН ЖОЖ СЪС САЛНИКОВ МЕХАНИЗЪМ МЕДИНГ
BRASS BALL VALVE FF LONG HANDLE WITH PRESS NUT UNDER THE HANDLE



Размер Dimension	Арт. № Item №	Баркод Barcode			
1/2"	4020	3800154007965	12/144	<input checked="" type="checkbox"/>	<input checked="" type="checkbox"/>
3/4"	4021	3800154007972	10/120	<input checked="" type="checkbox"/>	<input checked="" type="checkbox"/>
1"	4022	3800154007989	6/72	<input checked="" type="checkbox"/>	<input checked="" type="checkbox"/>
1 1/4"	4023	3800154007996	6/36	<input checked="" type="checkbox"/>	<input checked="" type="checkbox"/>
1 1/2"	4024	3800154008009	4/24	<input checked="" type="checkbox"/>	<input checked="" type="checkbox"/>
2"	4025	3800154008016	2/12	<input checked="" type="checkbox"/>	<input checked="" type="checkbox"/>
2 1/2"	474	3800154023569	2/8	<input checked="" type="checkbox"/>	<input checked="" type="checkbox"/>
3"	480	3800154022302	2/8	<input checked="" type="checkbox"/>	<input checked="" type="checkbox"/>
4"	481	3800154024559	2/4	<input checked="" type="checkbox"/>	<input checked="" type="checkbox"/>

СФЕРИЧЕН КРАН С ИЗПУСКАТЕЛ СЪС САЛНИКОВ МЕХАНИЗЪМ МЕДИНГ
BRASS BALL SEWAGE VALVE FF LONG HANDLE WITH PRESS NUT UNDER THE HANDLE



Размер Dimension	Арт. № Item №	Баркод Barcode			
1/2"	26	3800154008023	5/60	<input checked="" type="checkbox"/>	<input checked="" type="checkbox"/>
3/4"	27	3800154008030	6/72	<input checked="" type="checkbox"/>	<input checked="" type="checkbox"/>
1"	271	3800154008047	6/48	<input checked="" type="checkbox"/>	<input checked="" type="checkbox"/>
1 1/4"	28	3800154008054	6/36	<input checked="" type="checkbox"/>	<input checked="" type="checkbox"/>
1 1/2"	29	3800154008061	4/24	<input checked="" type="checkbox"/>	<input checked="" type="checkbox"/>
2"	30	3800154008078	2/12	<input checked="" type="checkbox"/>	<input checked="" type="checkbox"/>

СФЕРИЧЕН КРАН МЖ ДЪЛГА РЪКОХВАТКА МЕДИНГ
BRASS BALL VALVE FM LONG HANDLE



Размер Dimension	Арт. № Item №	Баркод Barcode			
1/2"	193	3800154008085	12/144	<input checked="" type="checkbox"/>	<input checked="" type="checkbox"/>
3/4"	194	3800154018572	10/120	<input checked="" type="checkbox"/>	<input checked="" type="checkbox"/>
1"	1941	3800154018589	6/72	<input checked="" type="checkbox"/>	<input checked="" type="checkbox"/>
1 1/4"	4014	3800154008153	3/36	<input checked="" type="checkbox"/>	<input checked="" type="checkbox"/>
1 1/2"	4015	3800154008160	4/24	<input checked="" type="checkbox"/>	<input checked="" type="checkbox"/>
2"	4016	3800154008177	2/12	<input checked="" type="checkbox"/>	<input checked="" type="checkbox"/>

ИЗПУСКАТЕЛ ЗА КРАН МЕДИНГ
SEWAGE END FOR BALL VALVE



Размер Dimension	Арт. № Item №	Баркод Barcode			
1/4"	4018	3800154008474	10/1000	<input checked="" type="checkbox"/>	<input checked="" type="checkbox"/>



МЕДИНИ СФЕРИЧНИ КРАНОВЕ BRASS BALL VALVES

СФЕРИЧЕН КРАН ЖЖ Т-РЪКОХВАТКА СЪС САЛНИКОВ МЕХАНИЗЪМ МЕДИНГ
BRASS BALL VALVE FF BUTTERFLY HANDLE WITH PRESS NUT UNDER THE HANDLE



Размер Dimension	Арт. № Item №	Баркод Barcode			
1/2"	4004	3800154008092	19/228	✓	✓
3/4"	4005	3800154008108	14/168	✓	✓
1"	4006	3800154008115	10/120	✓	✓

СФЕРИЧЕН КРАН МЖ Т-РЪКОХВАТКА СЪС САЛНИКОВ МЕХАНИЗЪМ МЕДИНГ
BRASS BALL VALVE FM BUTTERFLY HANDLE WITH PRESS NUT UNDER THE HANDLE



Размер Dimension	Арт. № Item №	Баркод Barcode			
1/2"	4007	3800154008122	19/228	✓	✓
3/4"	4008	3800154008139	14/168	✓	✓
1"	4009	3800154008146	10/120	✓	✓

СФЕРИЧЕН КРАН ММ Т-РЪКОХВАТКА СЪС САЛНИКОВ МЕХАНИЗЪМ МЕДИНГ
BRASS BALL VALVE MM BUTTERFLY HANDLE AND PRESS NUT UNDER THE HANDLE



Размер Dimension	Арт. № Item №	Баркод Barcode			
1/2"	7735	3800154031366	19/228	✓	✓
3/4"	7736	3800154031373	14/168	✓	✓
1"	7737	3800154031380	10/120	✓	✓

СФЕРИЧЕН КРАН С ПОДВИЖНА ГАЙКА ЖЖ СЪС САЛНИКОВ МЕХАНИЗЪМ МЕДИНГ
BRASS BALL VALVE WITH NUT FF BUTTERFLY HANDLE AND PRESS NUT



Размер Dimension	Арт. № Item №	Баркод Barcode			
1/2"	7738	3800154031397	12/144	✓	✓
3/4"	7739	3800154031403	10/120	✓	✓
1"	7740	3800154031410	5/60	✓	✓

СФЕРИЧЕН КРАН С ХОЛЕНДЪР СЪС САЛНИКОВ МЕХАНИЗЪМ МЕДИНГ
BRASS BALL VALVE STRAIGHT WITH UNION BUTTERFLY HANDLE WITH PRESS NUT



Размер Dimension	Арт. № Item №	Баркод Barcode			
1/2"	4010	3800154008184	12/144	✓	✓
3/4"	4011	3800154008191	10/120	✓	✓
1"	4012	3800154008207	5/60	✓	✓
1 1/4"	1703	3800154008214	3/12	✓	✓

СФЕРИЧЕН КРАН ЪГЛОВ С ХОЛЕНДЪР СЪС САЛНИКОВ МЕХАНИЗЪМ МЕДИНГ
BRASS ANGLE BALL VALVE WITH UNION BUTTERFLY HANDLE WITH PRESS NUT



Размер Dimension	Арт. № Item №	Баркод Barcode			
1/2"	412	3800154008221	12/144	✓	✓
3/4"	413	3800154008238	8/96	✓	✓
1"	414	3800154008245	7/42	✓	✓

THS
THERMOSTYLE



МЕСИНГОВИ МИНИ СФЕРИЧНИ КРАНОВЕ

MINI BRASS BALL VALVES

МИНИ СФЕРИЧЕН КРАН МЕСИНГ НИКЕЛ МЖ

MINI BRASS BALL VALVE NICKEL PLATED FM



МИНИ СФЕРИЧЕН КРАН МЕСИНГ НИКЕЛ ЖЖ

MINI BRASS BALL VALVE NICKEL PLATED FF

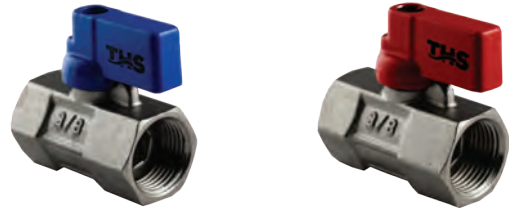

Размер Dimension	Арт. № Item №	Баркод Barcode			
3/8" СИНЯ РЪКОХВАТКА 3/8" BLUE HANDLE	420	3800154017100	28/336	<input checked="" type="checkbox"/>	
3/8" ЧЕРВЕНА РЪКОХВАТКА 3/8" RED HANDLE	4201	3800154017117	28/336	<input checked="" type="checkbox"/>	
1/2" СИНЯ РЪКОХВАТКА 1/2" BLUE HANDLE	41	3800154008382	24/288	<input checked="" type="checkbox"/>	
1/2" ЧЕРВЕНА РЪКОХВАТКА 1/2" RED HANDLE	42	3800154008399	24/288	<input checked="" type="checkbox"/>	
3/4" ЧЕРВЕНА РЪКОХВАТКА 3/4" RED HANDLE	424	3800154008405	12/144	<input checked="" type="checkbox"/>	

Размер Dimension	Арт. № Item №	Баркод Barcode			
3/8" СИНЯ РЪКОХВАТКА 3/8" BLUE HANDLE	43	3800154017087	28/336	<input checked="" type="checkbox"/>	
3/8" ЧЕРВЕНА РЪКОХВАТКА 3/8" RED HANDLE	4301	3800154017094	28/336	<input checked="" type="checkbox"/>	

МИНИ СФЕРИЧЕН КРАН МЕСИНГ ХРОМ МЖ

MINI BRASS BALL VALVE CHROME PLATED FM

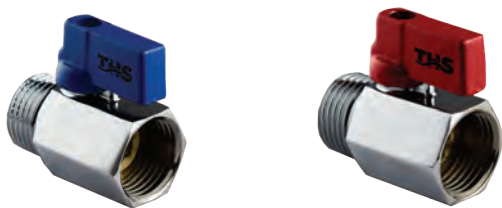

МИНИ СФЕРИЧЕН КРАН МЕСИНГ ХРОМ ЖЖ

MINI BRASS BALL VALVE CHROME PLATED FF

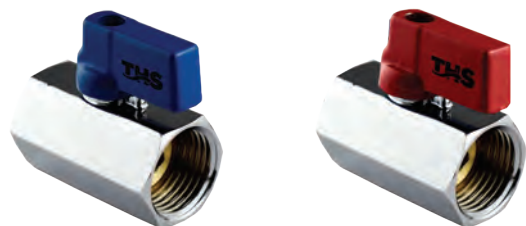

Размер Dimension	Арт. № Item №	Баркод Barcode			
1/2" СИНЯ РЪКОХВАТКА 1/2" BLUE HANDLE	431	3800154008368	24/288	<input checked="" type="checkbox"/>	
1/2" ЧЕРВЕНА РЪКОХВАТКА 1/2" RED HANDLE	432	3800154008375	24/288	<input checked="" type="checkbox"/>	

Размер Dimension	Арт. № Item №	Баркод Barcode			
1/2" СИНЯ РЪКОХВАТКА 1/2" BLUE HANDLE	4231	3800154017049	24/288	<input checked="" type="checkbox"/>	
1/2" ЧЕРВЕНА РЪКОХВАТКА 1/2" RED HANDLE	4232	3800154017056	24/288	<input checked="" type="checkbox"/>	

МИНИ СФЕРИЧЕН КРАН МЕСИНГ ХРОМ ММ

MINI BRASS BALL VALVE CHROME PLATED MM



Размер Dimension	Арт. № Item №	Баркод Barcode			
1/2" ЧЕРВЕНА РЪКОХВАТКА 1/2" RED HANDLE	419	3800154017124	24/288	<input checked="" type="checkbox"/>	

THS[®]
THERMOSTYLE





МЕСИНГОВИ ЪГЛОВИ КРАНОВЕ BRASS ANGLE VALVES

**СФЕРИЧЕН КРАН ЪГЛОВ МЕСИНГ ПОЛИРАН
С РОЗЕТКА И МЕТАЛНА РЪКОХВАТКА**
BRASS CHROME PLATED ANGLE BALL VALVE METAL HANDLE



Размер Dimension	Арт. № Item №	Баркод Barcode			
1/2" * 3/8"	4047	3800154015519	1/100		
1/2" * 1/2"	4094	3800154015502	1/100		
1/2" * 3/4"	4028	3800154015526	1/100		

**СФЕРИЧЕН КРАН ЪГЛОВ МЕСИНГ С ФИЛТЪР ПОЛИРАН
С РОЗЕТКА И МЕТАЛНА РЪКОХВАТКА**
BRASS CHROME PLATED ANGLE BALL VALVE WITH STRAINER AND METAL HANDLE



Размер Dimension	Арт. № Item №	Баркод Barcode			
1/2" * 3/8"	460	3800154008313	1/100		
1/2" * 1/2"	435	3800154008306	1/100		
1/2" * 3/4"	433	3800154008320	1/100		

ВКР МЕСИНГ ХРОМ С РОЗЕТКА И МЕТАЛНА РЪКОХВАТКА
BRASS CHROME PLATED ANGLE STOP VALVE WITH METAL HANDLE



Размер Dimension	Арт. № Item №	Баркод Barcode			
1/2" * 3/8"	425	3800154008252	1/200		
1/2" * 1/2"	4072	3800154008269	1/200		

**КРАН ЪГЛОВ МЕСИНГ С РОЗЕТКА И КЕРАМИЧНА ГЛАВА
PLATINIUM TURPEDO**
BRASS ANGLE STOP VALVE PLATINIUM TURPEDO



Размер Dimension	Арт. № Item №	Баркод Barcode			
1/2" * 3/8"	4074	3800154022111	1/100		
1/2" * 1/2"	4075	3800154022128	1/100		
1/2" * 3/4"	4076	3800154022135	1/100		

СПИРАТЕЛЕН ВЕНТИЛ МЕСИНГ С ДИСТАНЦИОННА ВТУЛКА
BRASS VALVE FOR WASHING MACHINE PIPE CHROME PLATED

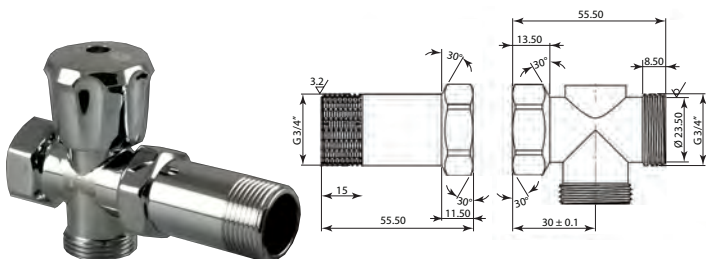

Размер Dimension	Арт. № Item №	Баркод Barcode			
3/4"	5909	3800154022289	1/96		

КРАН ТРОЕН МЕСИНГ ХРОМ
BRASS TEE ANGLE VALVE 3 WAYS CHROME PLATED



Размер Dimension	Арт. № Item №	Баркод Barcode			
1/2"М*3/4"М*1/2"Ж 1/2"М* 3/4"М*1/2"Ф	437	3800154008337	1/100		



МЕСИНГОВИ ЪГЛОВИ КРАНОВЕ BRASS ANGLE VALVES

СПИРАТЕЛЕН КРАН МЕСИНГ С ФИЛТЪР TOP BRASS ANGLE STOP VALVE WITH FILTER TOP

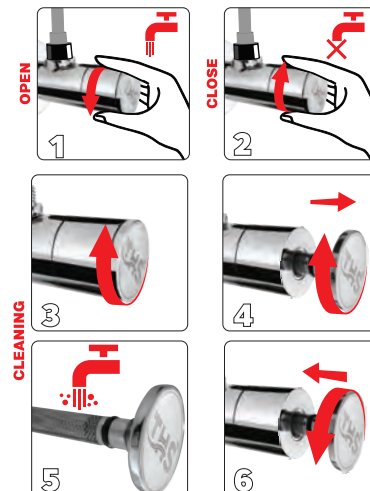

Размер Dimension	Арт. № Item №	Баркод Barcode			
1/2" * 3/8"	8983	3800154033117	1/80	<input checked="" type="checkbox"/>	
1/2" * 1/2"	8984	3800154033124	1/80	<input checked="" type="checkbox"/>	
1/2" * 3/4"	8985	3800154033131	1/80	<input checked="" type="checkbox"/>	

СПИРАТЕЛЕН КРАН МЕСИНГ OVAL BRASS ANGLE STOP VALVE OVAL



Размер Dimension	Арт. № Item №	Баркод Barcode			
1/2" * 1/2" CHROME	9978	3800154004285	1/80	<input checked="" type="checkbox"/>	
1/2" * 1/2" BLACK	9979	3800154004292	1/80	<input checked="" type="checkbox"/>	

СПИРАТЕЛЕН КРАН МЕСИНГ ROSE BRASS STOP VALVE SERIES ROSE



Размер Dimension	Арт. № Item №	Баркод Barcode			
1/2" * 1/2"	10006	3800154040580	1/200	<input checked="" type="checkbox"/>	

TMS[®]
THERMOSTYLE



МЕДИНГОВИ ЪГЛОВИ КРАНОВЕ
BRASS ANGLE VALVES

Серия TOP и SHARP

СПИРАТЕЛЕН ЪГЛОВ КРАН МЕДИНГ С РОЗЕТКА TOP SILVER
BRASS ANGLE VALVE WITH ANTI-SCRATCH ROSETTE TOP SILVER

Ø 10 mm



Размер Dimension	Арт. № Item №	Баркод Barcode			
1/2" * 3/8" С ГАЙКА Ø 10 mm 1/2" * 3/8" WITH NUT Ø 10 mm	4090	3800154022326	1/80		

СПИРАТЕЛЕН ЪГЛОВ КРАН МЕДИНГ С РОЗЕТКА TOP GOLD
BRASS ANGLE VALVE WITH ANTI-SCRATCH ROSETTE TOP GOLD

Ø 10 mm



Размер Dimension	Арт. № Item №	Баркод Barcode			
1/2" * 3/8" С ГАЙКА Ø 10 mm 1/2" * 3/8" WITH NUT Ø 10 mm	40901	3800154023842	1/80		



МЕСИНГОВИ ЪГЛОВИ КРАНОВЕ BRASS ANGLE VALVES

ВЪЗМОЖНИ ОПЦИИ ЗА МОНТАЖ POSSIBLE INSTALLATION OPTIONS

➔ **Монтаж с мека връзка с накрайник M10x1**
Installation with flexible hose M10x1



➔ **Монтаж с тръбичка Ø 10 mm**
Installation with pipe Ø 10 mm



ТРЪБИЧКА Ø 10 mm С НАКРАЙНИК ЗА СТОЯЩ СМЕСИТЕЛ
CHROME PLATED CU PIPE Ø 10 mm FOR WASH BASIN



Размер Dimension	Арт. № Item №	Баркод Barcode			
Ø 10 * 50 cm	6774	3800154028410	1/20		

ТРЪБИЧКА Ø 10 mm С МЕСИНГОВА ГАЙКА
CHROME PLATED CU PIPE Ø 10 mm WITH BRASS NUT



Размер Dimension	Арт. № Item №	Баркод Barcode			
3/8" * 40 cm	6770	3800154028373	1/20		
3/8" * 100 cm	6771	3800154028380	1/20		





Размер Dimension	Арт. № Item №	Баркод Barcode			
1/2" * 40 cm	6772	3800154028397	1/20		
1/2" * 100 cm	6773	3800154028403	1/20		

T.H.S.
THERMOSTYLE



МЕДИНГОВИ ЪГЛОВИ КРАНОВЕ BRASS ANGLE VALVES

РЕЗЕРВНИ ЧАСТИ ЗА ЪГЛОВИ МЕДИНГОВИ КРАНОВЕ СЕРИЯ TOP SPARE PARTS FOR BRASS ANGLE VALVES TOP

Арт.№ Item №	№ от схемата № from the scheme	Наименование размер Name and dimension	Баркод Barcode			
9502	(2)	ЗАТВАРЯЩ МЕХАНИЗЪМ ЗА СПИРАТЕЛЕН КРАН TOP SILVER/GOLD CAPTAGE FOR STOP VALVE TOP SILVER/GOLD	3800154023910	-		✗
40904	(3)	КАПАЧКА THS ЗА КРАН TOP SILVER CAP THS FOR STOP VALVE TOP SILVER	3800154023934	-		✗
40905	(3)	КАПАЧКА THS ЗА КРАН TOP GOLD CAP THS FOR STOP VALVE TOP GOLD	3800154023941	-		✗
9506	(4)	УПЛЪТНИТЕЛ С МЕДИНГОВ О-РИНГ ЗА Ø 10 ЗА СПИРАТЕЛЕН КРАН TOP SILVER/GOLD BARSS PART WITH O-RING 10 mm FOR STOP VALVE TOP SILVER/GOLD	3800154023972	-		✗
9504	(5)	МЕДИНГОВ ПРЕХОД 3/8" * Ø 10 SILVER ЗА СПИРАТЕЛЕН КРАН TOP SILVER BRASS PART 3/8" * 10 mm SILVER FOR STOP VALVE TOP SILVER	3800154023958	-		✗
9505	(5)	МЕДИНГОВ ПРЕХОД 3/8" * Ø 10 GOLD ЗА СПИРАТЕЛЕН КРАН TOP GOLD BRASS PART 3/8" * 10 mm GOLD FOR STOP VALVE TOP GOLD	3800154023965	-		✗
40902	(6)	КАПАЧКА С ОТВОР ЗА КРАН 1/2" * 3/8" С ГАЙКА Ø 10 mm TOP SILVER CAP WITH HOLE FOR STOP VALVE TOP SILVER	3800154023897	-		✗
40903	(6)	КАПАЧКА С ОТВОР ЗА КРАН 1/2" * 3/8" С ГАЙКА Ø 10 mm TOP GOLD THS CAP WITH HOLE FOR STOP VALVE TOP GOLD	3800154023903	-		✗
9500	(7)	РОЗЕТКА МЕДИНГ 1/2" TOP SILVER С УПЛЪТНИТЕЛ ПРОТИВ НАДРАСКВАНЕ BRASS ROSETTE 1/2" WITH ANTI-SCRATCH SEAL TOP SILVER	3800154023873	1/200		✓
9501	(7)	РОЗЕТКА МЕДИНГ 1/2" TOP GOLD С УПЛЪТНИТЕЛ ПРОТИВ НАДРАСКВАНЕ BRASS ROSETTE 1/2" WITH ANTI-SCRATCH SEAL TOP GOLD	3800154023880	1/200		✓
9503	(7)	УПЛЪТНИТЕЛ ПРОТИВ НАДРАСКВАНЕ ЗА РОЗЕТКА TOP SILVER/GOLD ANTI-SCRATCH SEAL TOP SILVER/GOLD	3800154023927	-		✗

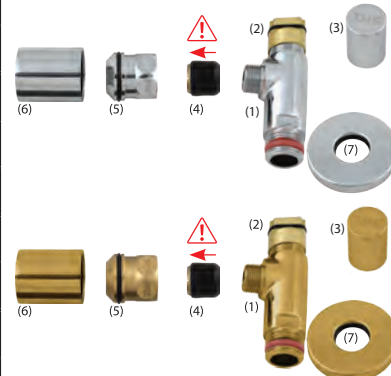

ИНСТРУКЦИИ ЗА МОНТАЖ

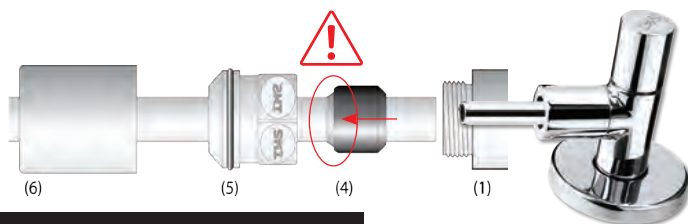

С ТРЪБИЧКА Ø 10 мм :

1. Препарайте тръбичката през капачката.(6)
2. Монтирайте месинговия преход 3/8" x Ø10 (5), като задължително спазвате посоката, указана на схемата.
3. Поставете уплътнението с месингов О-ринг за Ø10 (4) по начина, който е указан на схемата. Месинговата част трябва да е в посока към месинговия преход 3/8" x Ø10 (4).
4. Свържете тръбичката към мъжката резба на крана (1).
5. Преди да започнете притягане се уверете, че тръбичката е плътно прилепнала за крана.
6. Навийте месинговия преход 3/8" x Ø10 (5), с ключ №19 към мъжката резба на крана и поставете декоративната капачка с отвор (6) върху месинговия преход 3/8" x Ø10 (5), за целта използвайте подходящи професионални инструменти.

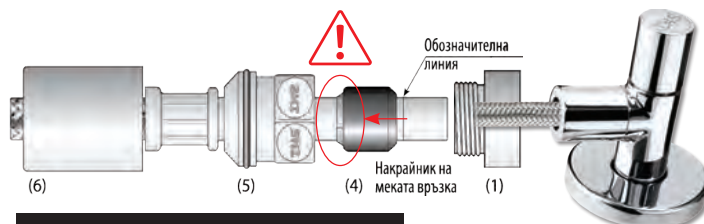

С МЕКА ВРЪЗКА:

1. Препарайте меката връзка през капачката с отвор.(6)
2. Монтирайте месинговия преход 3/8" x Ø10 (5), като задължително спазвате посоката, указана на схемата.
3. Поставете уплътнението с месингов О-ринг за Ø10 (4) по начина, който е указан на схемата. Месинговата част трябва да е в посока към месинговия преход 3/8" x Ø10 (4). Ако крайникът на меката връзка има обозначителна линия, уверете се, че уплътнението с месингов О-ринг за Ø10 е зад обозначителната линия, както е показано на схемата.
4. Свържете меката връзка към мъжката резба на крана (1).
5. Преди да започнете притягане се уверете, че тръбичката е плътно прилепнала за крана.
6. Навийте месинговия преход 3/8" x Ø10 (5) към мъжката резба на крана, с ключ №19 и поставете декоративната капачка с отвор (6) върху месинговия преход 3/8" x Ø10 (5), за целта използвайте подходящи професионални инструменти.

INSTRUCTION OF INSTALATION

WITH PIPE Ø 10 mm:

1. Pass the pipe through the cap. (6)
2. Install the brass adapter 3/8" x Ø 10 (5) as it's shown on the diagram above.
3. Place the brass O-ring seal for Ø10 (4) in the manner shown in the diagram. The brass part should be in the direction to the brass adapter 3/8" x Ø10 (4).
4. Connect the pipe to the male thread on the tap (1).
5. Before you begin the tightening, make sure the pipe is tightly attached to the crane.
6. Screw the brass adapter 3/8" x Ø10 (5) to the male thread on the tap and place the decorative cap with an opening (6) on the brass adapter, use appropriate professional tools for this.

WITH FLEXIBLE HOSE:

1. Pass the flexible hose through the cap with an opening (6).
2. Install the brass adapter 3/8" x Ø 10 (5) as it's shown on the diagram above.
3. Place the brass O-ring seal for Ø10 (4) in the manner shown in the diagram. The brass part should be in the direction to the brass adapter 3/8" x Ø10 (4). If there is a designating line on the end of the flexible hose, make sure that the brass O-ring seal for Ø10 is behind the designating line as shown in the diagram above.
4. Connect the flexible hose to the male thread on the tap (1).
5. Before you begin the tightening, make sure the pipe is tightly attached to the crane.
6. Screw the brass adapter 3/8" x Ø10 (5) to the male thread on the hose and place the decorative cap with an opening (6) on the brass adapter, use appropriate professional tools for this.



МЕДИНГОВИ ЪГЛОВИ КРАНОВЕ BRASS ANGLE VALVES

СПИРАТЕЛЕН ЪГЛОВ КРАН МЕДИНГ С РОЗЕТКА TOP SILVER BRASS ANGLE VALVE WITH ANTI-SCRATCH ROSETTE TOP SILVER

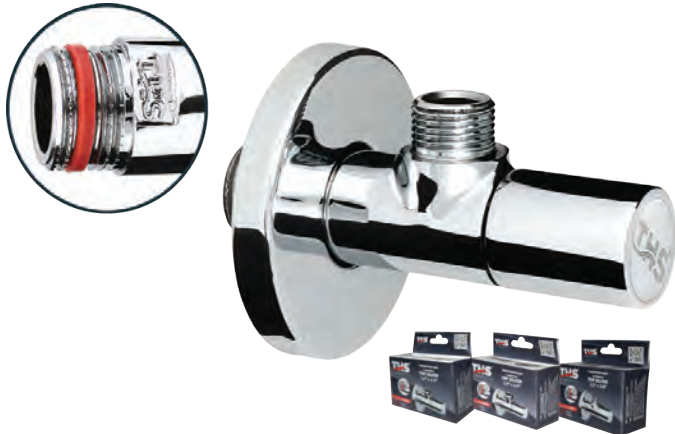

СПИРАТЕЛЕН ЪГЛОВ КРАН МЕДИНГ С РОЗЕТКА TOP GOLD BRASS ANGLE VALVE WITH ANTI-SCRATCH ROSETTE TOP GOLD



Размер Dimension	Арт. № Item №	Баркод Barcode			
1/2" * 3/8"	4091	3800154022319	1/80		✓
1/2" * 1/2"	4092	3800154022333	1/80		✓
1/2" * 3/4"	4093	3800154022340	1/80		✓

Размер Dimension	Арт. № Item №	Баркод Barcode			
1/2" * 3/8"	40911	3800154023835	1/80		✓
1/2" * 1/2"	40921	3800154023859	1/80		✓
1/2" * 3/4"	40931	3800154023866	1/80		✓

СПИРАТЕЛЕН ЪГЛОВ КРАН МЕДИНГ С РОЗЕТКА SHARP SILVER BRASS ANGLE VALVE SHARP SILVER



Комплектът включва тefлонова лента
The set includes PTFE



Размер Dimension	Арт. № Item №	Баркод Barcode			
1/2" * 3/8"	4031	3800154024009	1/100		✓
1/2" * 1/2"	4032	3800154023989	1/100		✓
1/2" * 3/4"	4033	3800154024023	1/100		✓

Размер Dimension	Арт. № Item №	Баркод Barcode			
1/2" * 3/8"	40311	3800154024016	1/100		✓
1/2" * 1/2"	40321	3800154023996	1/100		✓
1/2" * 3/4"	40331	3800154024030	1/100		✓

TMS[®]
THERMOSTYLE



МЕДИНГОВИ ЪГЛОВИ КРАНОВЕ BRASS ANGLE VALVES

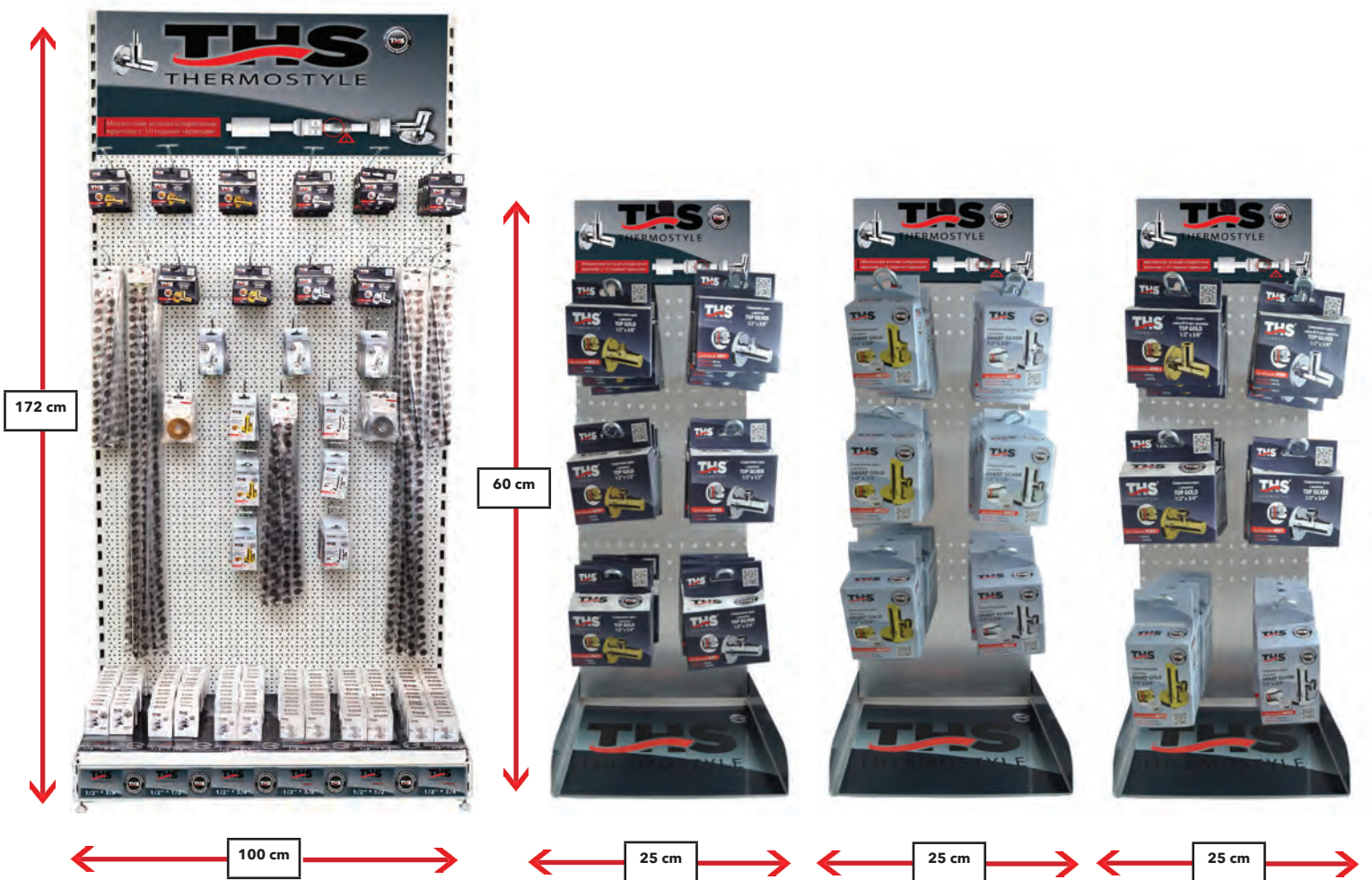

МЕДИНГОВА ВОДОПРОВОДНА АРМАТУРА BRASS WATER SUPPLY ARMATURE

ВЪЗВРАТЕН ВЕНТИЛ МЕДИНГ С ПЛАСТМАСОВ ДИСК BRASS CHECK VALVE PLASTIC DISC



Размер Dimension	Арт. № Item №	Баркод Barcode			
1/2"	51	3800154008481	32/384	✓	✓
3/4"	52	3800154008498	12/144	✓	✓
1"	53	3800154008504	10/120	✓	✓
1 1/4"	54	3800154008511	6/72	✓	✓
1 1/2"	55	3800154008528	6/72	✓	✓
2"	56	3800154008535	5/60	✓	✓

ВЪЗВРАТЕН ВЕНТИЛ МЕДИНГ СУИНГ С МЕДИНГОВ ДИСК BRASS CHECK VALVE HORIZONTAL INSTALLATION WITH BRASS DISC



Размер Dimension	Арт. № Item №	Баркод Barcode			
1/2"	510	3800154016295	16/160	✓	✓
3/4"	511	3800154016301	10/100	✓	✓
1"	512	3800154016318	8/64	✓	✓
1 1/4"	513	3800154016325	6/48	✓	✓
1 1/2"	514	3800154016332	5/40	✓	✓
2"	515	3800154016349	2/16	✓	✓

ВЪЗВРАТЕН ВЕНТИЛ МЕДИНГ С МЕДИНГОВ ДИСК BRASS CHECK VALVE WITH BRASS DISC



Размер Dimension	Арт. № Item №	Баркод Barcode			
1/2"	5111	3800154018985	16/192	✓	✓
3/4"	5112	3800154018992	12/144	✓	✓
1"	5113	3800154019005	9/108	✓	✓
1 1/4"	5114	3800154019012	6/72	✓	✓
1 1/2"	5115	3800154019029	6/36	✓	✓
2"	5116	3800154019036	3/18	✓	✓
2 1/2"	5118	3800154025129	3/12	✓	✓
3"	5119	3800154025136	3/12	✓	✓
4"	5120	3800154025143	1/6	✓	✓

СМУКАТЕЛ С МРЕЖА МЕДИНГ BRASS CHECK VALVE WITH SCREEN



Размер Dimension	Арт. № Item №	Баркод Barcode			
1/2"	615	3800154008542	18/144	✓	✓
3/4"	69	3800154008559	18/108	✓	✓
1"	610	3800154008566	12/72	✓	✓
1 1/4"	611	3800154008573	4/42	✓	✓
1 1/2"	612	3800154008580	4/36	✓	✓
2"	613	3800154008597	3/27	✓	✓

СМУКАТЕЛ НА РЕБРА МЕДИНГ BRASS CHECK VALVE WITH BRASS SCREEN



Размер Dimension	Арт. № Item №	Баркод Barcode			
3/4"	61	3800154016356	10/120	✓	✓
1"	62	3800154016363	12/144	✓	✓
1 1/4"	63	3800154016370	3/30	✓	✓
1 1/2"	64	3800154016387	4/42	✓	✓
2"	65	3800154016394	2/20	✓	✓





TMS
THERMOSTYLE



МЕСИНГОВА ВОДОПРОВОДНА АРМАТУРА BRASS WATER SUPPLY ARMATURE



ШИБЪРЕН ВЕНТИЛ МЕСИНГ BRASS GATE VALVE



Размер Dimension	Арт. № Item №	Баркод Barcode			
1/2"	31	3800154007934	10/100		✓
3/4"	32	3800154007941	10/100		✓
1"	33	3800154007958	5/50		✓
1 1/4"	34	3800154016653	5/50		✓
1 1/2"	35	3800154023224	4/40		✓
2"	36	3800154017032	2/20		✓

ФИЛТЪР ЗА ВОДА МЕСИНГ BRASS STRAINER Y TYPE



Размер Dimension	Арт. № Item №	Баркод Barcode			
1/2"	71	3800154008603	6/192		✓
3/4"	72	3800154008610	20/120		✓
1"	73	3800154008627	12/72		✓
1 1/4"	74	3800154008634	6/36		✓
1 1/2"	75	3800154008641	5/30		✓
2"	76	3800154008658	2/12		✓

РЕДУЦИР ВЕНТИЛ С ИЗВОД ЗА МАНОМЕТЪР МЕСИНГ BRASS PRESSURE REDUCER VALVE



Размер Dimension	Арт. № Item №	Баркод Barcode			
1/2"	2447	3800154008832	1/50		✓
3/4"	2451	3800154008849	1/50		✓





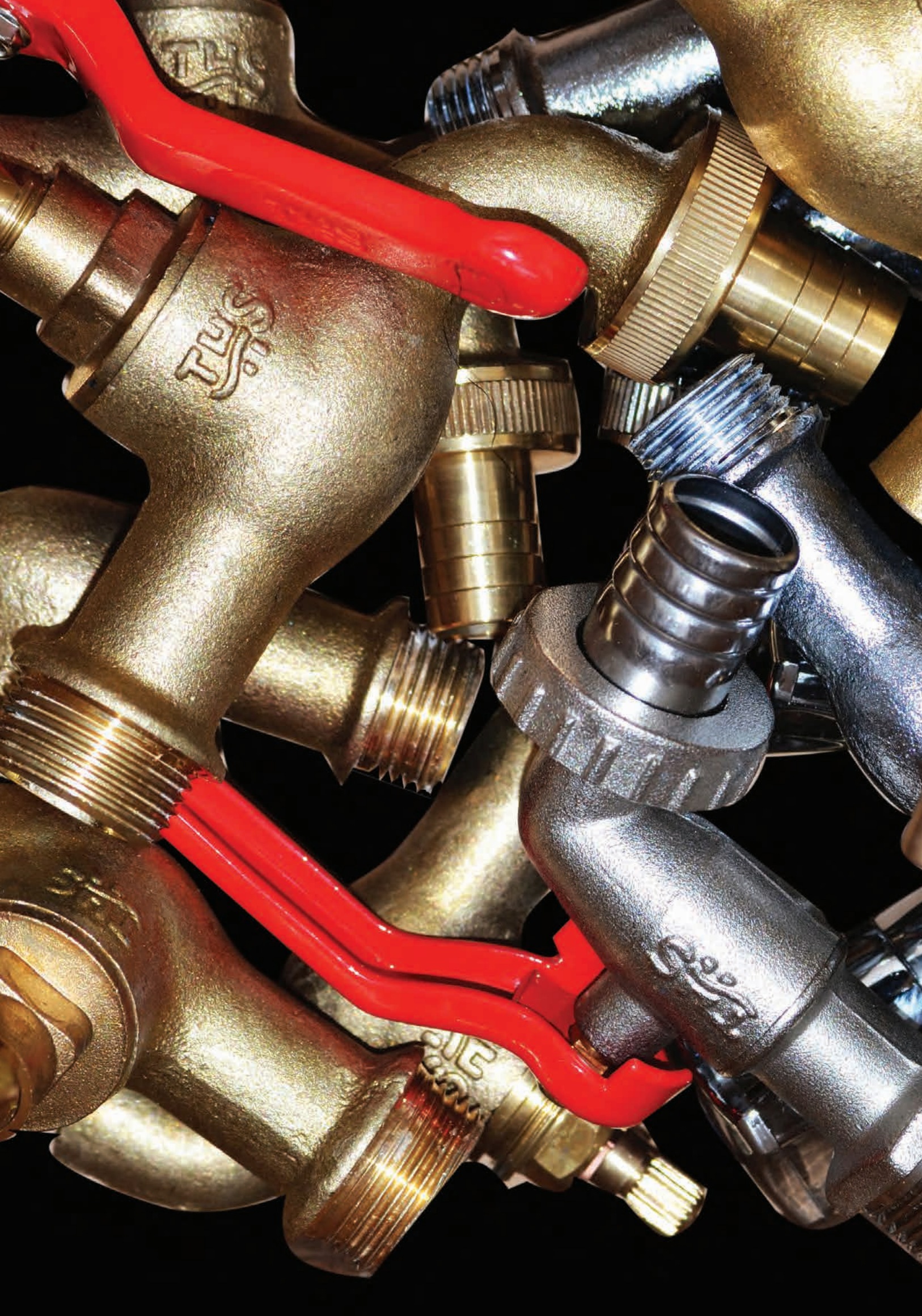

МЕДИНИ КАНЕЛИ BRASS BIBCOCKS

КАНЕЛА ДВОЙНА ANTI-FROST СЪС ЗАКЛЮЧВАНЕ МЕДИНГ BRASS BALL BIBCOCK ANTI-FROST WITH LOCK



Размер Dimension	Арт. № Item №	Баркод Barcode			
1/2" * 3/4"	9379	3800154037498	1/160		



КАНЕЛА ANTI-FROST СЪС ЗАКЛЮЧВАНЕ МЕДИНГ BRASS BALL BIBCOCK ANTI-FROST WITH LOCK



Размер Dimension	Арт. № Item №	Баркод Barcode			
1/2"	84262	3800154035111	1/84		



КАНЕЛА СФЕРИЧНА С КОНЕКТОР ТЕЖЪК МОДЕЛ МЕДИНГ BRASS BALL BIBCOCK WITH CONNECTOR HEAVY TYPE



Размер Dimension	Арт. № Item №	Баркод Barcode			
1/2"	6743	3800154027680	9/108		











КАНЕЛА СФЕРИЧНА МЕДИНГ BRASS BALL BIBCOCK



Размер Dimension	Арт. № Item №	Баркод Barcode			
1/2"	190	3800154008702	12/144		
3/4"	165	3800154008719	10/120		
1"	1651	3800154018954	4/48		











КАНЕЛА МИНИ МЕДИНГ BRASS BIBCOCK MINI



Размер Dimension	Арт. № Item №	Баркод Barcode			
1/2" СРЕБРО/CHROME PLATED	5834	3800154022012	10/100		
3/4" СРЕБРО/CHROME PLATED	5835	3800154022050	10/100		
1/2" ЗЛАТО/GOLD COLOR	5838	3800154022005	10/100		
3/4" ЗЛАТО/GOLD COLOR	5839	3800154022043	10/100		

КАНЕЛА МИНИ С ХОЛЕНДЪР МЕДИНГ BRASS BIBCOCK MINI WITH UNION FOR GARDEN HOSE



Размер Dimension	Арт. № Item №	Баркод Barcode			
1/2" СРЕБРО/CHROME PLATED	5836	3800154022036	10/100		
3/4" СРЕБРО/CHROME PLATED	5837	3800154022074	8/80		
1/2" ЗЛАТО/GOLD COLOR	5840	3800154022029	10/100		
3/4" ЗЛАТО/GOLD COLOR	5841	3800154022067	8/80		

МЕСИНГОВИ КАНЕЛИ BRASS BIBCOCKS

КАНЕЛА МЕСИНГ ШАГРЕН ТЕЖЪК МОДЕЛ BRASS STOP BIBCOCK



Размер Dimension	Арт. № Item №	Баркод Barcode			
1/2" ЖЪЛТА/YELLOW	463	3800154008740	1/60	<input checked="" type="checkbox"/>	<input checked="" type="checkbox"/>
3/4" ЖЪЛТА/YELLOW	4102	3800154008764	1/60	<input checked="" type="checkbox"/>	<input checked="" type="checkbox"/>
1/2" НИКЕЛ/NICKEL PLATED	464	3800154016813	1/60	<input checked="" type="checkbox"/>	<input checked="" type="checkbox"/>

КАНЕЛА С ХОЛЕНДЪР МЕСИНГ ШАГРЕН ТЕЖЪК МОДЕЛ YELLOW BRASS STOP BIBCOCK WITH UNION FOR GARDEN HOSE



Размер Dimension	Арт. № Item №	Баркод Barcode			
1/2" ЖЪЛТА/YELLOW	446	3800154008757	1/60	<input checked="" type="checkbox"/>	<input checked="" type="checkbox"/>
3/4" ЖЪЛТА/YELLOW	4101	3800154008771	1/60	<input checked="" type="checkbox"/>	<input checked="" type="checkbox"/>

КАНЕЛА С НАКРАЙНИК ТИП БЪРЗА ВРЪЗКА МЕСИНГ/НИКЕЛ ШАГРЕН YELLOW/NICKEL BRASS STOP BIBCOCK WITH QUICK CONNECTOR



Размер Dimension	Арт. № Item №	Баркод Barcode			
1/2"	7495	3800154029363	1/60	<input checked="" type="checkbox"/>	<input checked="" type="checkbox"/>
3/4"	7496	3800154029387	1/60	<input checked="" type="checkbox"/>	<input checked="" type="checkbox"/>
1/2" НИКЕЛ/NICKEL PLATED	1405	3800154016820	1/60	<input checked="" type="checkbox"/>	<input checked="" type="checkbox"/>
3/4" НИКЕЛ/NICKEL PLATED	9143	3800154035043	1/60	<input checked="" type="checkbox"/>	<input checked="" type="checkbox"/>

КАНЕЛА С НАКРАЙНИК ТИП БЪРЗА ВРЪЗКА НИКЕЛ ШАГРЕН BRASS STOP BIBCOCK WITH UNION FOR GARDEN HOSE NICKEL PLATED



Размер Dimension	Арт. № Item №	Баркод Barcode			
1/2" ВИТА/VITA	5794	3800154021725	1/60	<input checked="" type="checkbox"/>	<input checked="" type="checkbox"/>
1/2" ДАЛИЯ/DALIA	5795	3800154021732	1/60	<input checked="" type="checkbox"/>	<input checked="" type="checkbox"/>
1/2" РОСИЦА/ROSITSA	5796	3800154021749	1/60	<input checked="" type="checkbox"/>	<input checked="" type="checkbox"/>
1/2" ИСКЪР БЯЛА/ISKAR WHITE	5797	3800154021756	1/60	<input checked="" type="checkbox"/>	<input checked="" type="checkbox"/>
1/2" ИСКЪР ХРОМ/ISKAR CHROME	5798	3800154021763	1/60	<input checked="" type="checkbox"/>	<input checked="" type="checkbox"/>

КАНЕЛА МЕСИНГ ШАГРЕН АБМ РЪКОХВАТКА YELLOW BRASS STOP BIBCOCK WITH WHITE HANDLE



Размер Dimension	Арт. № Item №	Баркод Barcode			
1/2" ЖЪЛТА/YELLOW	4631	3800154021565	1/60	<input checked="" type="checkbox"/>	<input checked="" type="checkbox"/>
1/2" С НАКРАЙНИК БЪРЗА ВРЪЗКА/ WITH QUICK CONNECTOR	4461	3800154021572	1/60	<input checked="" type="checkbox"/>	<input checked="" type="checkbox"/>

КЕКЛА ЗА КАНЕЛА CARTAGE FOR STOP BIBCOCK



Размер Dimension	Арт. № Item №	Баркод Barcode			
1/2" ЖЪЛТА/YELLOW	1501	3800154008818	10/200	<input checked="" type="checkbox"/>	<input checked="" type="checkbox"/>
3/4" ЖЪЛТА/YELLOW	1502	3800154008825	10/200	<input checked="" type="checkbox"/>	<input checked="" type="checkbox"/>
1/2" НИКЕЛ/NICKEL PLATED	1505	3800154021541	10/200	<input checked="" type="checkbox"/>	<input checked="" type="checkbox"/>
3/4" НИКЕЛ/NICKEL PLATED	1506	3800154021558	10/200	<input checked="" type="checkbox"/>	<input checked="" type="checkbox"/>

МЕДИНГОВИ КАНЕЛИ BRASS BIBCOCKS

КАНЕЛА 9 cm МЕДИНГ ХРОМ ПОЛИРАНА BIBCOCK 9 cm BRASS CHROME PLATED



Размер Dimension	Арт. № Item №	Баркод Barcode			
1/2" ВИТА/VITA	8933	3800154008788	1/60		
1/2" ДАЛИЯ/DALIA	434	3800154016837	1/60		
1/2" ИСКЪР БЯЛА/ISKAR WHITE	1598009	3800154021848	1/60		
1/2" ИСКЪР ХРОМ/ISKAR CHROME	8934	3800154021800	1/60		
1/2" РОСИЦА/ROSITSA	1504	3800154021824	1/60		
1/2" АБМ/AMB	8932	3800154022104	1/60		
1/2" РЕТРО/RETRO	7556	3800154030192	1/60		

КАНЕЛА 15 cm МЕДИНГ ХРОМ ПОЛИРАНА BIBCOCK 15 cm BRASS CHROME PLATED



Размер Dimension	Арт. № Item №	Баркод Barcode			
1/2" ВИТА/VITA	462	3800154008795	1/50		
1/2" ДАЛИЯ/DALIA	436	3800154016844	1/50		
1/2" ИСКЪР БЯЛА/ISKAR WHITE	1598015	3800154021855	1/50		
1/2" ИСКЪР ХРОМ/ISKAR CHROME	8960	3800154021817	1/50		
1/2" РОСИЦА/ROSITSA	1503	3800154021831	1/50		
1/2" АБМ/AMB	4621	3800154022098	1/50		
1/2" РЕТРО/RETRO	7557	3800154030185	1/50		

КАНЕЛА ДВОЙНА МЕДИНГ BIBCOCK DOUBLE EXIT BRASS CHROME PLATED



Размер Dimension	Арт. № Item №	Баркод Barcode			
1/2" * 3/4"	1500	3800154008801	1/80		

ФОНТАНКА ЗА СТЕНА МЕДИНГ BRASS FOUNTAIN BUBBLER



Размер Dimension	Арт. № Item №	Баркод Barcode			
1/2"	862	3800154029424	1/20		



TMS
THERMOSTYLE



МЕСИНГОВИ КАНЕЛИ BRASS BIBCOCKS

КАНЕЛА ДЕКОРАТИВНА СПИРАТЕЛНА ЛЪВ МЕСИНГ DECORATIVE BRASS BALL BIBCOCK / LION



Размер Dimension	Арт. № Item №	Баркод Barcode			
1/2"	439	3800154008733	1/30		

КАНЕЛА ДЕКОРАТИВНА СФЕРИЧНА ЛЪВ МЕСИНГ DECORATIVE BRASS STOP BIBCOCK / LION



Размер Dimension	Арт. № Item №	Баркод Barcode			
1/2"	438	3800154008726	1/30		

ЗАТВАРЯЩИ МЕХАНИЗЪМИ ЗА ДЕКОРАТИВНИ КАНЕЛИ ЛЪВ CARTAGES FOR DECORATIVE BRASS BALL BIBCOCKS / LION



43901

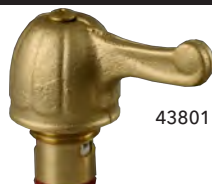

43801

Размер Dimension	Арт. № Item №	Баркод Barcode			
1/2"	43801	3800154040351	1/100		
1/2"	43901	3800154040368	1/100		

КАНЕЛА ДЕКОРАТИВНА СПИРАТЕЛНА КЪЛВАЧ МЕСИНГ DECORATIVE BRASS STOP BIBCOCK WOODPECKER



Размер Dimension	Арт. № Item №	Баркод Barcode			
1/2"	4393	3800154025686	1/30		

КАНЕЛА ДЕКОРАТИВНА СПИРАТЕЛНА РИБА МЕСИНГ DECORATIVE BRASS STOP BIBCOCK FISH



Размер Dimension	Арт. № Item №	Баркод Barcode			
1/2"	4394	3800154025679	1/30		

КАНЕЛА ДЕКОРАТИВНА СПИРАТЕЛНА ЖАБА МЕСИНГ DECORATIVE BRASS STOP BIBCOCK FROG



Размер Dimension	Арт. № Item №	Баркод Barcode			
1/2"	4395	3800154025662	1/30		

КАНЕЛА ДЕКОРАТИВНА СПИРАТЕЛНА ПЕТЕЛ МЕСИНГ DECORATIVE BRASS STOP BIBCOCK ROOSTER



Размер Dimension	Арт. № Item №	Баркод Barcode			
1/2"	4392	3800154025655	1/30		

КАНЕЛА ДЕКОРАТИВНА СПИРАТЕЛНА ПАТЕ МЕСИНГ DECORATIVE BRASS STOP BIBCOCK DUCK



Размер Dimension	Арт. № Item №	Баркод Barcode			
1/2"	4396	3800154025693	1/30		

ХОЛЕНДЪР ЗА ВОДОМЕР МЕСИНГ
BRASS UNION FOR WATER METER



Размер Dimension	Арт. № Item №	Баркод Barcode			
1/2" * 3/4"	1619	3800154004537	1/170	<input checked="" type="checkbox"/>	<input checked="" type="checkbox"/>
3/4" * 1"	169	3800154004544	1/130	<input checked="" type="checkbox"/>	<input checked="" type="checkbox"/>
1" * 1 1/4"	1601	3800154025617	1/100	<input checked="" type="checkbox"/>	<input checked="" type="checkbox"/>

НАКРАЙНИК И ГАЙКА БЪРЗА ВРЪЗКА ЗА КАНЕЛА
BRASS QUICK CONNECTOR FOR GARDEN HOSE



Размер Dimension	Арт. № Item №	Баркод Barcode			
1/2"	7407	3800154029370	1/100	<input checked="" type="checkbox"/>	<input checked="" type="checkbox"/>
3/4"	7497	3800154029394	1/100	<input checked="" type="checkbox"/>	<input checked="" type="checkbox"/>

ЩУЦЕР ЗА МАРКУЧ
BRASS UNION FOR GARDEN HOSE



Размер Dimension	Арт. № Item №	Баркод Barcode			
1/2" M * 12 mm	175	3800154008856	10/700	<input type="checkbox"/>	<input checked="" type="checkbox"/>
3/4" M * 20 mm	176	3800154008863	10/400	<input type="checkbox"/>	<input checked="" type="checkbox"/>
1" M * 25 mm	178	3800154008870	10/220	<input type="checkbox"/>	<input checked="" type="checkbox"/>

МЕДИНГОВИ ХРОМИРАНИ ФИТИНГИ BRASS FITTINGS CHROME PLATED

УДЪЛЖИТЕЛ ДЕБЕЛОСТЕНЕН В САМОСТОЯТЕЛНА ОПАКОВКА TAG/БЛИСТЕР МЕДИНГ ХРОМ
BRASS CHROME PLATED EXTENSIONS TAG/ SINGLE BLISTER HEAVY TYPE



Размер Dimension	Арт. № Item №	Баркод Barcode			
3/8" * 10 mm	18287	3800154031663	10/400	✓	✓
3/8" * 15 mm	18292	3800154031670	10/300	✓	✓
3/8" * 20 mm	18293	3800154031687	10/280	✓	✓
3/8" * 25 mm	18294	3800154031694	10/240	✓	✓
3/8" * 30 mm	18295	3800154031700	10/240	✓	✓
3/8" * 40 mm	18296	3800154031717	10/180	✓	✓
3/8" * 50 mm	18297	3800154031724	10/140	✓	✓
3/8" * 60 mm	18298	3800154031731	10/120	✓	✓

Размер Dimension	Арт. № Item №	Баркод Barcode			
1/2" * 10 mm	187092	3800154025006	1/250	✓	✓
1/2" * 15 mm	187093	3800154025013	1/250	✓	✓
1/2" * 20 mm	187094	3800154025020	1/250	✓	✓
1/2" * 25 mm	187095	3800154025037	1/250	✓	✓
1/2" * 30 mm	187096	3800154025044	1/250	✓	✓
1/2" * 40 mm	187097	3800154025051	1/140	✓	✓
1/2" * 50 mm	187098	3800154025068	1/140	✓	✓
1/2" * 60 mm	187099	3800154025075	1/140	✓	✓
1/2" * 70 mm	187100	3800154025082	1/120	✓	✓
1/2" * 80 mm	187101	3800154025099	1/120	✓	✓
1/2" * 90 mm	187102	3800154025105	1/120	✓	✓
1/2" * 100 mm	187103	3800154025112	1/120	✓	✓

УДЪЛЖИТЕЛ МЕДИНГ ХРОМ 1/2" BRASS CHROME PLATED EXTENSION

УДЪЛЖИТЕЛ МЕДИНГ ХРОМ 3/4" BRASS CHROME PLATED EXTENSION



Размер Dimension	Арт. № Item №	Баркод Barcode			
1/2" * 10 mm	18092	3800154002809	10/400	X	X
1/2" * 15 mm	18093	3800154002816	10/300	X	X
1/2" * 20 mm	18094	3800154002823	10/280	X	X
1/2" * 25 mm	18095	3800154002830	10/240	X	X
1/2" * 30 mm	18096	3800154002847	10/240	X	X
1/2" * 40 mm	18097	3800154002854	10/180	X	X
1/2" * 50 mm	18098	3800154002861	10/140	X	X
1/2" * 60 mm	18099	3800154002878	10/120	X	X
1/2" * 70 mm	180100	3800154002885	10/110	X	X
1/2" * 80 mm	180101	3800154002892	10/110	X	X
1/2" * 90 mm	180102	3800154002908	10/100	X	X
1/2" * 100 mm	180103	3800154002915	10/100	X	X

Размер Dimension	Арт. № Item №	Баркод Barcode			
3/4" * 10 mm	18104	3800154002922	10/200	X	X
3/4" * 15 mm	18105	3800154002939	10/350	X	X
3/4" * 20 mm	18106	3800154002946	10/140	X	X
3/4" * 25 mm	18107	3800154002953	10/200	X	X
3/4" * 30 mm	18108	3800154002960	10/350	X	X
3/4" * 40 mm	18109	3800154002977	10/180	X	X
3/4" * 50 mm	18110	3800154002984	10/150	X	X
3/4" * 60 mm	18111	3800154002991	5/100	X	X
3/4" * 70 mm	18112	3800154003004	10/100	X	X
3/4" * 80 mm	18113	3800154003011	10/80	X	X
3/4" * 90 mm	18114	3800154003028	10/80	X	X
3/4" * 100 mm	18115	3800154003035	10/80	X	X



МЕСИНГОВИ ХРОМИРАНИ ФИТИНГИ BRASS FITTINGS CHROME PLATED

НИПЕЛ МЕСИНГ ХРОМ NIPPEL BRASS CHROME PLATED



Размер Dimension	Арт. № Item №	Баркод Barcode			
1/4"	18691	3800154021350	10/900	X	X
3/8"	1867	3800154003042	10/500	X	X
1/2"	1868	3800154003059	10/400	X	X
1/2" TM	181868	3800154033193	10/400	✓	X
3/4"	1869	3800154003066	10/120	X	X
1"	1870	3800154003073	10/120	X	X

НИПЕЛ РЕДУКТИВЕН МЕСИНГ ХРОМ NIPPEL REDUCING BRASS CHROME PLATED



Размер Dimension	Арт. № Item №	Баркод Barcode			
1/2" * 1/4"	186107	3800154023149	10/500	X	X
1/2" * 3/8"	1871	3800154003080	10/400	X	X
3/4" * 1/2"	1872	3800154003097	10/250	X	X
1" * 1/2"	1850	3800154003103	15/210	X	X
1" * 3/4"	1816	3800154003110	10/150	X	X

МУФА МЕСИНГ ХРОМ SOCKET BRASS CHROME PLATED



Размер Dimension	Арт. № Item №	Баркод Barcode			
3/8"	1843	3800154003127	10/300	X	X
1/2"	1873	3800154003134	10/250	X	X
1/2" TM	181873	3800154033216	10/250	✓	X
3/4"	1874	3800154003141	10/150	X	X
1"	1875	3800154003158	10/100	X	X

МУФА РЕДУКТИВНА МЕСИНГ ХРОМ SOCKET REDUCING BRASS CHROME PLATED



Размер Dimension	Арт. № Item №	Баркод Barcode			
1/2" * 3/8"	1841	3800154003165	10/300	X	X
3/4" * 1/2"	1842	3800154003172	10/200	X	X
1" * 1/2"	18205	3800154003189	10/210	X	X
1" * 3/4"	18206	3800154003196	10/180	X	X

МУФА НИПЕЛ МЕСИНГ ХРОМ ЖМ SOCKET NIPPEL BRASS CHROME PLATED FM



Размер Dimension	Арт. № Item №	Баркод Barcode			
1/2" * 1/2"	186105	3800154023156	10/250	X	X
3/4" * 3/4"	186106	3800154023163	10/200	X	X

МУФА НИПЕЛ РЕДУКТИВНА МЕСИНГ ХРОМ ЖМ SOCKET REDUCER NIPPEL BRASS CHROME PLATED FM



Размер Dimension	Арт. № Item №	Баркод Barcode			
1/2" * 3/8"	1876	3800154003202	10/450	X	X
3/4" * 1/2"	1877	3800154003219	10/250	X	X
1" * 1/2"	18208	3800154003226	10/140	X	X
1" * 3/4"	18207	3800154003233	10/140	X	X

МЕСИНГОВИ ХРОМИРАНИ ФИТИНГИ

BRASS FITTINGS CHROME PLATED

ВРЪН МЕСИНГ ХРОМ МЖ

BUSHING BRASS CHROME PLATED MF



Размер Dimension	Арт. № Item №	Баркод Barcode			
1/2" * 1/4"	18300	3800154003240	10/800	X	X
1/2" * 3/8"	1878	3800154003257	10/500	X	X
3/4" * 1/2"	1879	3800154003264	10/450	X	X
1" * 1/2"	18200	3800154003271	10/240	X	X
1" * 3/4"	189	3800154003288	10/500	X	X
1 1/4" * 3/4"	18223	3800154023170	10/120	X	X
1 1/4" * 1"	18224	3800154021343	10/160	X	X

ТАПА С УПЛЪТНИТЕЛ МЕСИНГ ХРОМ

END BRASS MALE WITH RUBBER



Размер Dimension	Арт. № Item №	Баркод Barcode			
1/2"	24161	3800154003295	10/500	X	X

ТАПА МЕСИНГ ХРОМ

END CAP BRASS CHROME PLATED MALE



Размер Dimension	Арт. № Item №	Баркод Barcode			
3/8"	18305	3800154003301	10/1600	X	X
1/2"	1864	3800154003318	10/600	X	X
3/4"	1865	3800154003325	10/600	X	X
1"	18204	3800154003332	10/240	X	X

КАПА МЕСИНГ ХРОМ

END CAP BRASS CHROME PLATED FEMALE



Размер Dimension	Арт. № Item №	Баркод Barcode			
3/8"	18306	3800154003356	10/600	X	X
1/2"	1866	3800154003363	10/500	X	X
3/4"	18202	3800154003370	10/350	X	X
1"	18203	3800154003387	20/400	X	X

КОЛЯНО МЕСИНГ ХРОМ ЖЖ

ELBOW BRASS CHROME PLATED FF



Размер Dimension	Арт. № Item №	Баркод Barcode			
3/8"	1854	3800154003400	10/300	X	X
1/2"	1855	3800154003417	10/160	X	X
1/2" TM	181855	3800154033209	10/160	✓	X
3/4"	1856	3800154003424	10/90	X	X
1"	1881	3800154003431	10/70	X	X

КОЛЯНО РЕДУКТОР МЕСИНГ ХРОМ ЖЖ

ELBOW REDUCER BRASS CHROME PLATED FF



Размер Dimension	Арт. № Item №	Баркод Barcode			
3/4" * 1/2"	18225	3800154023187	10/120	X	X
1" * 1/2"	18209	3800154025709	10/100	X	X
1" * 3/4"	18210	3800154025716	10/100	X	X

THS[®]
THERMOSTYLE



МЕДИНГОВИ ХРОМИРАНИ ФИТИНГИ

BRASS FITTINGS CHROME PLATED

КОЛЯНО НИПЕЛ МЕДИНГ ХРОМ МЖ

ELBOW BRASS CHROME PLATED FM



Размер Dimension	Арт. № Item №	Баркод Barcode			
3/8"	1857	3800154003448	10/300	X	X
1/2"	1858	3800154003455	10/160	X	X
1/2" TM	181858	3800154033223	10/160	✓	X
3/4"	1859	3800154003462	10/100	X	X
1"	1882	3800154003479	10/70	X	X

КОЛЯНО РЕДУКТОР МЕДИНГ ХРОМ ЖМ

ELBOW REDUCER BRASS CHROME PLATED FM



Размер Dimension	Арт. № Item №	Баркод Barcode			
1/2" * 3/4"	18211	3800154024320	10/150	X	X

КОЛЯНО МЕДИНГ ХРОМ ММ

ELBOW BRASS CHROME PLATED MM



Размер Dimension	Арт. № Item №	Баркод Barcode			
1/2"	1851	3800154003486	10/200	X	X
3/4"	18212	3800154003493	10/100	X	X

ТРОЙНИК МЕДИНГ ХРОМ ЖЖЖ

TEE BRASS CHROME PLATED FFF



Размер Dimension	Арт. № Item №	Баркод Barcode			
3/8"	1860	3800154003509	10/180	X	X
1/2"	1861	3800154003516	10/140	X	X
1/2" TM	181861	3800154033230	10/140	✓	X
3/4"	1862	3800154003523	10/60	X	X
1"	1880	3800154003530	10/40	X	X

ТРОЙНИК РЕДУКТИВЕН МЕДИНГ ХРОМ ЖЖЖ

TEE REDUCER BRASS CHROME PLATED FFF



Размер Dimension	Арт. № Item №	Баркод Barcode			
3/4" * 1/2" * 3/4"	18214	3800154025723	10/120	X	X
1" * 1/2" * 1"	18215	3800154025730	10/80	X	X
1" * 3/4" * 1"	18222	3800154025747	10/70	X	X

ТРОЙНИК МЕДИНГ ХРОМ МММ

TEE BRASS CHROME PLATED MMM





Размер Dimension	Арт. № Item №	Баркод Barcode			
1/2"	18219	3800154003547	10/150	X	X
3/4"	18220	3800154003554	10/70	X	X
1"	18221	3800154003561	10/140	X	X

МЕДИНГОВИ ХРОМИРАНИ ФИТИНГИ BRASS FITTINGS CHROME PLATED



ТРОЙНИК МЕДИНГ ХРОМ ЖМЖ TEE BRASS CHROME PLATED FMF



Размер Dimension	Арт. № Item №	Баркод Barcode			
1/2" * 1/2" * 1/2"	18216	3800154003578	10/120	X	X
3/4" * 3/4" * 3/4"	18218	3800154025761	10/80	X	X



ТРОЙНИК РЕДУКТИВЕН МЕДИНГ ХРОМ ЖМЖ TEE REDUCER BRASS CHROME PLATED FMF



Размер Dimension	Арт. № Item №	Баркод Barcode			
3/4" * 1/2" * 3/4"	18217	3800154025754	10/120	X	X

КРЪСТАЧКА МЕДИНГ ХРОМ CROSS BRASS CHROME PLATED



Размер Dimension	Арт. № Item №	Баркод Barcode			
1/2"	18201	3800154003394	10/90	X	X
3/4"	186108	3800154023132	10/60	X	X

МУФА НИПЕЛ УДЪЛЖИТЕЛ МЕДИНГ ХРОМ BRASS SOCKET NIPPEL EXTENSION

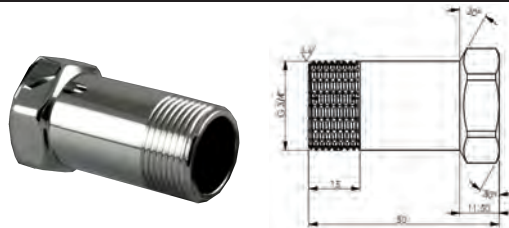

Размер Dimension	Арт. № Item №	Баркод Barcode			
3/4" x 50 mm	8488	3800154032547	1/100	X	X



TMS[®]
THERMOSTYLE







МЕСИНГОВИ ФИТИНГИ BRASS FITINGS

УДЪЛЖИТЕЛ МЕСИНГ ПОЛИРАН 1/2" BRASS CHROME POLISHED EXTENSION 1/2"



Размер Dimension	Арт. № Item №	Баркод Barcode			
1/2" * 10 mm	19092	3800154031786	10/400		✓
1/2" * 15 mm	19093	3800154031793	10/300		✓
1/2" * 20 mm	19094	3800154031809	10/280		✓
1/2" * 25 mm	19095	3800154031816	10/240		✓
1/2" * 30 mm	19096	3800154031823	10/240		✓
1/2" * 40 mm	19097	3800154031830	10/180		✓
1/2" * 50 mm	19098	3800154031847	10/140		✓
1/2" * 60 mm	19099	3800154031854	10/120		✓
1/2" * 70 mm	190100	3800154031861	10/110		✓
1/2" * 80 mm	190101	3800154031878	10/110		✓
1/2" * 90 mm	190102	3800154031885	10/100		✓
1/2" * 100 mm	190103	3800154031892	10/100		✓

УДЪЛЖИТЕЛ МЕСИНГ ШАГРЕН 1/2" BRASS EXTENSION 1/2"



Размер Dimension	Арт. № Item №	Баркод Barcode			
1/2" * 10 mm	197092	3800154031908	10/250		✓
1/2" * 15 mm	197093	3800154031915	10/250		✓
1/2" * 20 mm	197094	3800154031922	10/250		✓
1/2" * 25 mm	197095	3800154031939	10/250		✓
1/2" * 30 mm	197096	3800154031946	10/250		✓
1/2" * 40 mm	197097	3800154031953	10/140		✓
1/2" * 50 mm	197098	3800154031960	10/140		✓
1/2" * 60 mm	197099	3800154031977	10/140		✓

УДЪЛЖИТЕЛ МЕСИНГ ШАГРЕН 3/4" BRASS EXTENSION 3/4"



Размер Dimension	Арт. № Item №	Баркод Barcode			
3/4" * 10 mm	19104	3800154031984	10/200		✓
3/4" * 15 mm	19105	3800154031991	10/350		✓
3/4" * 20 mm	19106	3800154032004	10/140		✓
3/4" * 25 mm	19107	3800154032011	10/200		✓
3/4" * 30 mm	19108	3800154032028	10/350		✓
3/4" * 40 mm	19109	3800154032035	10/180		✓
3/4" * 50 mm	19110	3800154032042	10/150		✓
3/4" * 60 mm	19111	3800154032059	10/100		✓

УДЪЛЖИТЕЛ МЕСИНГ ШАГРЕН 1" BRASS EXTENSION 1"



Размер Dimension	Арт. № Item №	Баркод Barcode			
1" * 10 mm	198348	3800154032066	10/200		✓
1" * 15 mm	198349	3800154032073	10/150		✓
1" * 20 mm	198350	3800154032080	10/130		✓
1" * 25 mm	198351	3800154032097	10/120		✓
1" * 30 mm	198352	3800154032103	10/100		✓
1" * 40 mm	198353	3800154032110	10/80		✓
1" * 50 mm	198354	3800154032127	10/70		✓

МЕСИНГОВИ ФИТИНГИ BRASS FITINGS

НИПЕЛ МЕСИНГ NIPPEL BRASS



Размер Dimension	Арт. № Item №	Баркод Barcode			
3/8"	1967	3800154028557	10/600	X	X
1/2"	1968	3800154022647	10/400	X	X
3/4"	1969	3800154022654	10/200	X	X
1"	1970	3800154022661	10/120	X	X
1 1/4"	19307	3800154022678	5/60	X	X
1 1/2"	19308	3800154022685	5/45	X	X
2"	19309	3800154022692	4/36	X	X

МУФА МЕСИНГ SOCKET BRASS



Размер Dimension	Арт. № Item №	Баркод Barcode			
3/8"	1943	3800154028618	10/300	X	X
1/2"	1973	3800154022470	10/250	X	X
3/4"	1974	3800154022487	10/150	X	X
1"	1975	3800154022494	10/100	X	X
1 1/4"	19301	3800154022500	5/45	X	X
1 1/2"	196135	3800154022517	5/40	X	X
2"	196136	3800154022524	2/30	X	X

МУФА НИПЕЛ РЕДУКТИВНА МЕСИНГ МЖ SOCKET NIPPEL BRASS FM



Размер Dimension	Арт. № Item №	Баркод Barcode			
1/2" * 3/8"	1976	3800154028571	10/450	X	X
3/4" * 1/2"	1977	3800154022531	10/250	X	X
1" * 3/4"	19207	3800154022548	10/120	X	X
1 1/4" * 1"	196182	3800154023248	5/60	X	X

НИПЕЛ РЕДУКТИВЕН МЕСИНГ NIPPEL REDUCER BRASS



Размер Dimension	Арт. № Item №	Баркод Barcode			
1/2" * 3/8"	1971	3800154022708	10/400	X	X
3/4" * 1/2"	1972	3800154022715	10/250	X	X
1" * 1/2"	1950	3800154022722	10/180	X	X
1" * 3/4"	1916	3800154022739	10/150	X	X
1 1/4" * 1/2"	19632	3800154022760	10/80	X	X
1 1/4" * 3/4"	19631	3800154022753	10/80	X	X
1 1/4" * 1"	19630	3800154022746	10/80	X	X
1 1/2" * 3/4"	19635	3800154022791	5/50	X	X
1 1/2" * 1"	19634	3800154022784	5/50	X	X
1 1/2" * 1 1/4"	19633	3800154022777	5/45	X	X
2" * 1"	19638	3800154022821	5/40	X	X
2" * 1 1/4"	19637	3800154022814	5/40	X	X
2" * 1 1/2"	19636	3800154022807	5/40	X	X

МУФА РЕДУКТИВНА МЕСИНГ SOCKET REDUCER BRASS



Размер Dimension	Арт. № Item №	Баркод Barcode			
3/4" * 1/2"	1942	3800154023231	10/200	X	X
1 1/4" * 1"	199216	2000001992166	5/60	X	X

ТРОЙНИК МММ TEE BRASS MMM



Размер Dimension	Арт. № Item №	Баркод Barcode			
1/2"	19219	3800154040412	10/150	X	X
3/4"	19220	3800154040429	10/70	X	X

THS
THERMOSTYLE



МЕДИНГОВИ ФИТИНГИ BRASS FITINGS

ВРН МЕДИНГ МЖ BUSHING BRASS MF



Размер Dimension	Арт. № Item №	Баркод Barcode			
1/2" * 1/4"	19300	3800154028564	10/600	X	X
1/2" * 3/8"	1978	3800154022838	10/600	X	X
3/4" * 1/2"	1979	3800154022845	10/400	X	X
1" * 1/2"	19200	3800154022852	10/200	X	X
1" * 3/4"	199	3800154022869	10/200	X	X
1 1/4" * 3/4"	19223	3800154022883	10/120	X	X
1 1/4" * 1"	19224	3800154022876	10/120	X	X
1 1/2" * 1"	1988	3800154022906	10/70	X	X
1 1/2" * 1 1/4"	1987	3800154022890	10/70	X	X
2" * 3/4"	1989	3800154022913	5/45	X	X
2" * 1"	1990	3800154022920	5/45	X	X
2" * 1 1/4"	1991	3800154022937	5/45	X	X
2" * 1 1/2"	1992	3800154022944	5/45	X	X

КАПА МЕДИНГ CAP BRASS FEMALE



Размер Dimension	Арт. № Item №	Баркод Barcode			
1/2"	1966	3800154022951	10/500	X	X
3/4"	19202	3800154022968	10/350	X	X
1"	19203	3800154022975	10/200	X	X
1 1/4"	196157	3800154022982	10/120	X	X
1 1/2"	196158	3800154022999	10/80	X	X
2"	196159	3800154023002	5/60	X	X

ТАПА МЕДИНГ CAP BRASS MALE



Размер Dimension	Арт. № Item №	Баркод Barcode			
1/2"	1964	3800154023019	10/600	X	X
3/4"	1965	3800154023026	10/400	X	X
1"	19204	3800154023033	10/240	X	X

КОЛЯНО МЕДИНГ ЖЖ ELBOW BRASS FF



Размер Dimension	Арт. № Item №	Баркод Barcode			
3/8"	1954	3800154028588	10/300	X	X
1/2"	1955	3800154022555	10/160	X	X
3/4"	1956	3800154022562	10/90	X	X
1"	1981	3800154022579	5/50	X	X

КОЛЯНО МЕДИНГ ЖМ ELBOW BRASS FM



Размер Dimension	Арт. № Item №	Баркод Barcode			
3/8"	1957	3800154028595	10/300	X	X
1/2"	1958	3800154022586	10/160	X	X
3/4"	1959	3800154022593	10/100	X	X
1"	1982	3800154022609	5/70	X	X

ТРОЙНИК МЕДИНГ ЖЖЖ TEE BRASS FFF



Размер Dimension	Арт. № Item №	Баркод Barcode			
3/8"	1960	3800154028601	10/180	X	X
1/2"	1961	3800154022616	10/100	X	X
3/4"	1962	3800154022623	5/60	X	X
1"	1980	3800154022630	5/40	X	X

THS
THERMOSTYLE



МЕДИНГОВИ НИКЕЛИРАНИ ФИТИНГИ

BRASS FITINGS NICKEL PLATED

НИПЕЛ МЕДИНГ НИКЕЛ

NIPPEL BRASS NICKEL PLATED



Размер Dimension	Арт. № Item №	Баркод Barcode			
3/8"	2067	3800154024566	10/600	X	X
1/2"	2068	3800154024573	10/400	X	X
3/4"	2069	3800154024580	10/200	X	X
1"	2070	3800154024597	10/120	X	X

НИПЕЛ РЕДУКТИВЕН МЕДИНГ НИКЕЛ

NIPPEL REDUCING BRASS NICKEL PLATED



Размер Dimension	Арт. № Item №	Баркод Barcode			
1/2" * 3/8"	2071	3800154024603	10/400	X	X
3/4" * 1/2"	2072	3800154024610	10/250	X	X

МУФА МЕДИНГ НИКЕЛ ЖЖ

SOCKET BRASS NICKEL PLATED FF



Размер Dimension	Арт. № Item №	Баркод Barcode			
1/2"	2073	3800154024627	10/250	X	X
3/4"	2074	3800154024634	10/150	X	X
1"	2075	3800154024641	10/100	X	X

МУФА НИПЕЛ МЕДИНГ НИКЕЛ МЖ

SOCKET NIPPEL BRASS NICKEL PLATED FM



Размер Dimension	Арт. № Item №	Баркод Barcode			
1/2" * 3/8"	2076	3800154024658	10/450	X	X
3/4" * 1/2"	2077	3800154024665	10/250	X	X

МУФА РЕДУКТИВНА МЕДИНГ НИКЕЛ

SOCKET REDUCER BRASS NICKEL PLATED



Размер Dimension	Арт. № Item №	Баркод Barcode			
1/2" * 3/8"	2041	3800154024672	10/300	X	X
3/4" * 1/2"	20421	3800154024689	10/200	X	X

ВРН МЕДИНГ НИКЕЛ МЖ

BUSHING BRASS NICKEL PLATED MF



Размер Dimension	Арт. № Item №	Баркод Barcode			
1/2" x 1/4"	20300	3800154045400	10/600	X	X
1/2" * 3/8"	2078	3800154024696	10/600	X	X
3/4" * 1/2"	2079	3800154024702	10/400	X	X

МЕСИНГОВИ НИКЕЛИРАНИ ФИТИНГИ BRASS FITINGS NICKEL PLATED

ТАПА МЕСИНГ НИКЕЛ CAP BRASS NICKEL PLATED MALE



Размер Dimension	Арт. № Item №	Баркод Barcode			
1/2"	2064	3800154024719	10/600	X	X
3/4"	2065	3800154024726	10/400	X	X
1"	2024	3800154024733	10/240	X	X

КАПА МЕСИНГ НИКЕЛ CAP BRASS NICKEL PLATED FEMALE

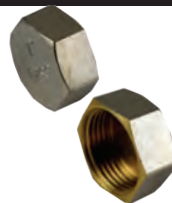

Размер Dimension	Арт. № Item №	Баркод Barcode			
1/2"	2066	3800154024740	10/500	X	X
3/4"	2022	3800154024757	10/350	X	X
1"	2023	3800154024764	10/200	X	X

КОЛЯНО МЕСИНГ НИКЕЛ ЖЖ ELBOW BRASS NICKEL PLATED FF



Размер Dimension	Арт. № Item №	Баркод Barcode			
3/8"	2026	3800154024771	10/300	X	X
1/2"	2055	3800154024788	10/160	X	X
3/4"	2056	3800154024795	10/90	X	X
1"	2081	3800154024801	5/50	X	X

КОЛЯНО НИПЕЛ МЕСИНГ НИКЕЛ МЖ ELBOW BRASS NICKEL PLATED FM



Размер Dimension	Арт. № Item №	Баркод Barcode			
3/8"	2057	3800154028625	10/300	X	X
1/2"	2090	3800154024818	10/160	X	X
3/4"	2091	3800154024825	10/100	X	X
1"	2082	3800154024832	5/70	X	X

ТРОЙНИК МЕСИНГ НИКЕЛ ЖЖЖ TEE BRASS NICKEL PLATED FFF



Размер Dimension	Арт. № Item №	Баркод Barcode			
3/8"	2051	3800154024849	10/180	X	X
1/2"	2061	3800154024856	10/100	X	X
3/4"	2062	3800154024863	10/60	X	X
1"	2080	3800154024870	5/40	X	X

THS
THERMOSTYLE



МЕДИНГОВИ ХОЛЕНДРИ И ПРЕДПАЗНИ ВЕНТИЛИ

BRASS UNIONS AND SAFETY VALVES

ХОЛЕНДЪР ПРАВ РАДИАТОРЕН МЕДИНГ НИКЕЛ

STRAIGHT UNION WITH EXTENSION BRASS NICKEL PLATED FM



Размер Dimension	Арт. № Item №	Баркод Barcode			
1/2"	115	3800154007873	10/140	X	X
3/4"	116	3800154007880	5/80	X	X
1"	117	3800154007897	5/40	X	X

ХОЛЕНДЪР ЪГЛОВ РАДИАТОРЕН МЕДИНГ НИКЕЛ

ANGLE UNION WITH EXTENSION BRASS NICKEL PLATED FM



Размер Dimension	Арт. № Item №	Баркод Barcode			
1/2"	1036	3800154007903	10/100	X	X
3/4"	1037	3800154007910	5/60	X	X
1"	1090	3800154007927	5/25	X	X

ХОЛЕНДЪР ПРАВ РАДИАТОРЕН МЕДИНГ

STRAIGHT UNION WITH EXTENSION BRASS FM



Размер Dimension	Арт. № Item №	Баркод Barcode			
1/2"	19115	3800154028496	10/140	X	X
3/4"	19116	3800154028502	5/80	X	X
1"	19117	3800154028519	5/40	X	X

ХОЛЕНДЪР ЪГЛОВ РАДИАТОРЕН МЕДИНГ

ANGLE UNION WITH EXTENSION BRASS FM



Размер Dimension	Арт. № Item №	Баркод Barcode			
1/2"	191036	3800154028526	10/100	X	X
3/4"	191037	3800154028533	5/60	X	X
1"	1090	3800154007927	5/25	X	X

ПРЕДПАЗЕН ВЕНТИЛ ЗА БОЙЛЕР

SAFETY BRASS VALVE



Размер Dimension	Арт. № Item №	Баркод Barcode			
1/2"	166	3800154008887	1/84		✓

ПРЕДПАЗЕН ВЕНТИЛ ЗА БОЙЛЕР С ЛОСТЧЕ

SAFETY BRASS VALVE WITH PLATE



Размер Dimension	Арт. № Item №	Баркод Barcode			
1/2"	167	3800154008894	1/84		✓

Предпазният вентил е фабрично настроен на 8 бара - за артикули № 166 и № 167
The safety valve is set to 8 bars. - items № 166 and № 167

TMS[®]
THERMOSTYLE





ОБОРУДВАНЕ ЗА БАНЯ
BATHROOM EQUIPMENT

Rainbow



Blackmatt



Rose



Rose

МЕСИНГОВИ СМЕСИТЕЛИ BRASS MIXERS

**СМЕСИТЕЛ ЗА ДУШ - ПЪЛЕН СЕТ СЕРИЯ ROSE
BATH AND SHOWER MIXER FULL SET SERIES ROSE**

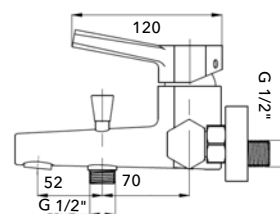
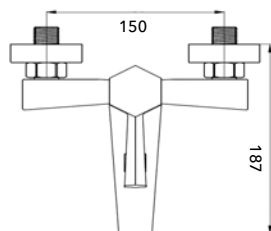
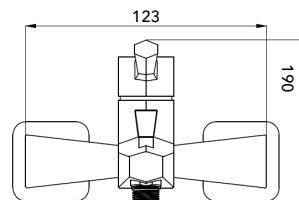

Размер Dimension	Арт. № Item №	Баркод Barcode			
Ø 35	10004	3800154040573	1/4		

**СМЕСИТЕЛ ЗА МИВКА К-Т С ВИТЛО СЕРИЯ ROSE
BASIN SET WITH POP-UP SERIES ROSE**

**СПИРАТЕЛЕН КРАН СЕРИЯ ROSE
BRASS STOP VALVE SERIES ROSE**



Размер Dimension	Арт. № Item №	Баркод Barcode			
Ø 35	10005	3800154040566	1/10		

Размер Dimension	Арт. № Item №	Баркод Barcode			
1/2" * 1/2"	10006	3800154040580	1/200		

The High Standard bathroom equipment for new experience

TMS
THERMOSTYLE



МЕДИНГОВИ СМЕСИТЕЛИ
BRASS MIXERS

Rainbow

СМЕСИТЕЛ ЗА ДУШ - ПЪЛЕН СЕТ СЕРИЯ RAINBOW
BATH AND SHOWER MIXER FULL SET SERIES RAINBOW

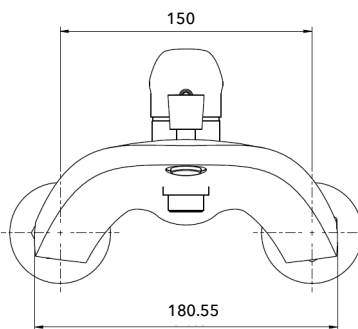
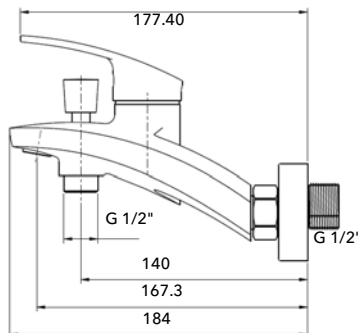
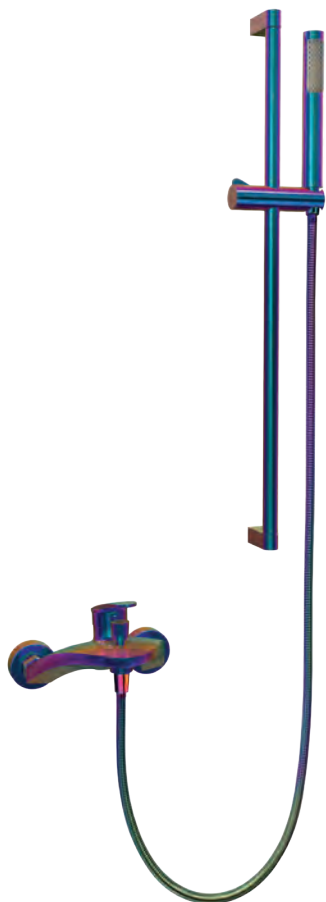

Размер Dimension	Арт. № Item №	Баркод Barcode			
Ø 35	99611	3800154004186	1/4		

СМЕСИТЕЛ ЗА МИВКА СТОЯЩ БАНЯ КОМПЛЕКТ С ВИТЛО СЕРИЯ RAINBOW
BASIN SET WITH POP UP SERIES RAINBOW

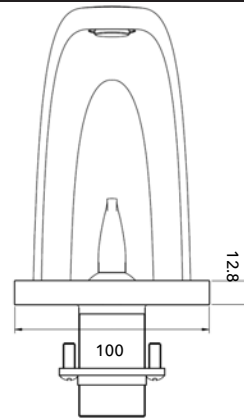
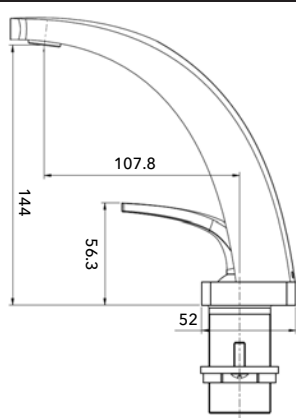
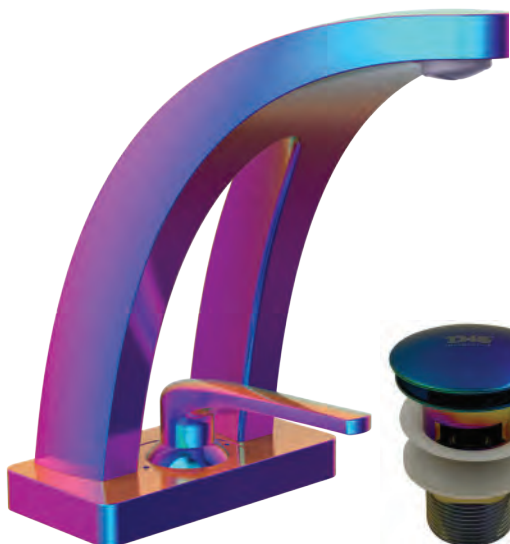

Размер Dimension	Арт. № Item №	Баркод Barcode			
Ø 25	99612	3800154004179	1/4		

The High Standard bathroom equipment for new experience



ДОЗАТОР ЗА ТЕЧЕН САПУН СЕРИЯ RAINBOW SOAP DISPENSER & HOLDER SERIES RAINBOW



Размер Dimension	Арт. № Item №	Баркод Barcode	
	99617	3800154004230	1/2

ЧЕТКА ЗА WC ЗА СТЕНА СЕРИЯ RAINBOW TOILET BRUSH & HOLDER FOR WC SERIES RAINBOW



Размер Dimension	Арт. № Item №	Баркод Barcode	
	99618	3800154004247	1/20

ДЪРЖАЧ ЗА ТООЛЕТНА ХАРТИЯ СЕРИЯ RAINBOW HOLDER FOR TOILET PAPPER SERIES RAINBOW

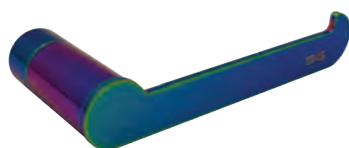

Размер Dimension	Арт. № Item №	Баркод Barcode	
L167 мм	99615	3800154004216	1/50

ЗАКАЧАЛКА СЕРИЯ RAINBOW ROBE HOOK SERIES RAINBOW

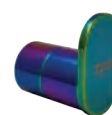

Размер Dimension	Арт. № Item №	Баркод Barcode	
	99616	3800154004223	1/100

ОКАЧВАНЕ ЗА ХАВЛИЯ СЕРИЯ RAINBOW RAINBOW TOWEL HANGING

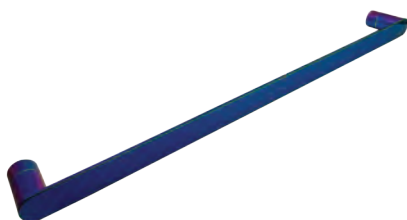

Размер Dimension	Арт. № Item №	Баркод Barcode	
L632мм	99614	3800154004209	1/20

ПОДОВ СИФОН С КЛАПА СЕРИЯ RAINBOW FLOOR DRAINER SERIES RAINBOW

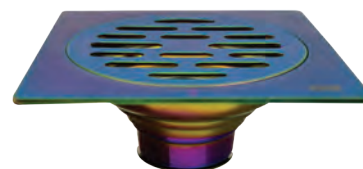

Размер Dimension	Арт. № Item №	Баркод Barcode	
Ø50- 100mmx100mm	99613	3800154004193	1/40

The High Standard bathroom equipment for new experience

МЕДИНГОВИ СМЕСИТЕЛИ
BRASS MIXERS

Blackmatt

СМЕСИТЕЛ ЗА ДУШ - ПЪЛЕН СЕТ СЕРИЯ BLACKMATT
BATH AND SHOWER MIXER FULL SET SERIES BLACKMATT

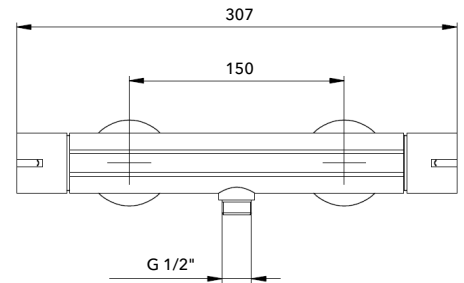
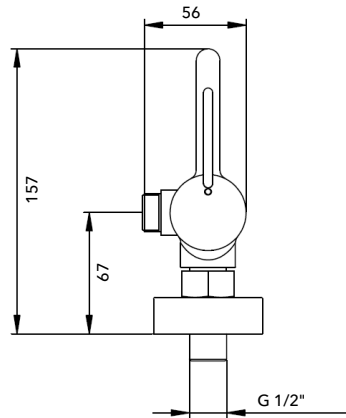

Размер Dimension	Арт. № Item №	Баркод Barcode			
Ø 30	9969	3800154004254	1/4		✓

СМЕСИТЕЛ ЗА МИВКА СТОЯЩ ЗА БАНЯ СЕРИЯ BLACKMATT
BASIN SERIES BLACKMATT

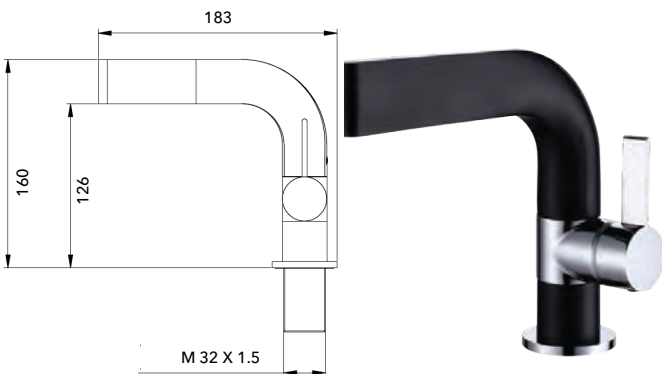

Размер Dimension	Арт. № Item №	Баркод Barcode			
Ø 25	9970	3800154004261	1/10		✓

ПОДОВ СИФОН С КЛАПА СЕРИЯ BLACKMATT
FLOOR DRAINER SERIES BLACKMATT



Размер Dimension	Арт. № Item №	Баркод Barcode			
Ø50- 100x100mm	9971	3800154004278	1/40		✓

The High Standard bathroom equipment for new experience





**ЕДНОРЪКОХВАТКОВ ИНТИМЕН СМЕСИТЕЛ ЗА ВЪНШЕН МОНТАЖ
СЪС ЗАТВАРЯЩ МЕХАНИЗЪМ T.H.S by SEDAL
SHATAFF FULL SET WITH CARTAGE T.H.S by SEDAL**

Пълен комплект готов за монтаж и експлоатация, включващ:

1. Компактен едноръкохватков смесител за нормален външен монтаж, включващ магнитен държач за душчето.
- Междуосово разстояние за монтаж - 10 cm;
- Затварящ керамичен механизъм 25 mm - T.H.S by Sedal;
2. Метален хигиенен стоп душ 1/2" с магнитна глава, необходима за прихващане към тялото;
3. Шлаух 1/2" 120 cm с двойна оплетка и месингови накрайници. Шлаухът в комплекта е с функция ANTI-TWIST, с помощта на която се предотвратява усукването на шлауха;
4. Масивни месингови розетки с диаметър 60 mm и дълбочина 21mm - 2 бр.;
5. Присъединителни ексцентрици 1/2" * 3/4" - 2 бр.;
6. Луксозна кутия, гаранционна карта и инструкция за експлоатация.







**Магнитно прикрепване на стоп душа.
Magnetic attachment of the stop shower.**



Complete ready-to-install and operating kit including:

1. Compact single handle mixer for normal outdoor installation including magnetic shower holder.
- Central distance for instalation - 10 cm;
- 25 mm ceramic cartage - T.H.S by Sedal;
2. Metal hygienic stop shower 1/2" with magnetic head required for attaching to the body;
3. Shower hose 1/2" 120 cm with double braid and brass nuts. The hose has ANTI-TWIST function, which prevents the hose from twisting;
4. Massive brass rosettes with a diameter of 60 mm and a depth of 21 mm - 2 pcs;
5. Connection eccentrics 1/2" * 3/4" - 2 pcs;
6. Luxury box, warranty card and manual instruction.



Цвят Color	Арт. № Item №	Баркод Barcode			
Черен мат / Black matt	8486	3800154032523	1/20		
Хром / Chrome	8487	3800154032530	1/20		



T.H.S.
THERMOSTYLE



МЕСИНГОВИ СМЕСИТЕЛИ BRASS MIXERS

PHILIPPOLIS



Арт. № Item №	Баркод Barcode			
99659	3800154047091	1/10		



Арт. № Item №	Баркод Barcode			
99660	3800154047114	1/10		



Арт. № Item №	Баркод Barcode			
99658	3800154047077	1/10		

PLISKA BLACK



Арт. № Item №	Баркод Barcode			
99683	3800154047565	1/10		



Арт. № Item №	Баркод Barcode			
99682	3800154047541	1/10		

PLISKA WHITE



Арт. № Item №	Баркод Barcode			
99685	3800154047596	1/10		



Арт. № Item №	Баркод Barcode			
99684	3800154047572	1/10		



МЕДИНГОВИ СМЕСИТЕЛИ
BRASS MIXERS

ZLATOGRAD



Арт. № Item №	Баркод Barcode			
99686	3800154047626	1/10		



Арт. № Item №	Баркод Barcode			
99688	3800154047664	1/10		



Арт. № Item №	Баркод Barcode			
99687	3800154047640	1/10		

NIKOPOL



Арт. № Item №	Баркод Barcode			
99639	3800154046896	1/10		



Арт. № Item №	Баркод Barcode			
99640	3800154046919	1/10		



Арт. № Item №	Баркод Barcode			
99638	3800154046872	1/10		

KALOFER



Арт. № Item №	Баркод Barcode			
99642	3800154046933	1/10		



Арт. № Item №	Баркод Barcode			
99650	3800154046971	1/10		



Арт. № Item №	Баркод Barcode			
99649	3800154046957	1/10		



МЕДИНГОВИ СМЕСИТЕЛИ BRASS MIXERS

SEXAGINTA PRISTA



Арт. № Item №	Баркод Barcode			
99680	3800154047503	1/10		



Арт. № Item №	Баркод Barcode			
99681	3800154047527	1/10		



Арт. № Item №	Баркод Barcode			
99679	3800154047480	1/10		

SERDIKA



Арт. № Item №	Баркод Barcode			
99690	3800154047701	1/10		



Арт. № Item №	Баркод Barcode			
99691	3800154047725	1/10		



Арт. № Item №	Баркод Barcode			
99689	3800154047688	1/10		

SREDEC



Арт. № Item №	Баркод Barcode			
99674	3800154047374	1/10		

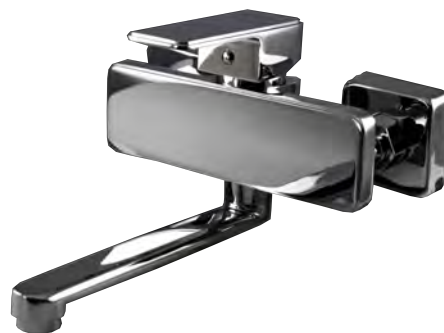

Арт. № Item №	Баркод Barcode			
99676	3800154047428	1/10		



Арт. № Item №	Баркод Barcode			
99675	3800154047404	1/10		

TMS[®]
THERMOSTYLE



МЕДИНГОВИ СМЕСИТЕЛИ
BRASS MIXERS

SOFIA



Арт. № Item №	Баркод Barcode			
99662	3800154047152	1/10		



Арт. № Item №	Баркод Barcode			
99661	3800154047138	1/10		



Арт. № Item №	Баркод Barcode			
99664	3800154047190	1/10		



Арт. № Item №	Баркод Barcode			
99663	3800154047176	1/10		

DOROSTOL



Арт. № Item №	Баркод Barcode			
99672	3800154047343	1/10		

ODESSUS



Арт. № Item №	Баркод Barcode			
99673	3800154047350	1/10		

TMS[®]
THERMOSTYLE



МЕДИНГОВИ СМЕСИТЕЛИ BRASS MIXERS

TERVEL



Арт. № Item №	Баркод Barcode			
99654	3800154046995	1/10		



Арт. № Item №	Баркод Barcode			
99655	3800154047015	1/10		



Арт. № Item №	Баркод Barcode			
99657	3800154047053	1/10		



Арт. № Item №	Баркод Barcode			
99656	3800154047039	1/10		

TAURUS



Арт. № Item №	Баркод Barcode			
99668	3800154047282	1/10		



Арт. № Item №	Баркод Barcode			
99669	3800154047305	1/10		



Арт. № Item №	Баркод Barcode			
99667	3800154047268	1/10		



МЕДИНГОВИ СМЕСИТЕЛИ
BRASS MIXERS

BALCHIK



Арт. № Item №	Баркод Barcode			
99677	3800154047442	1/10		

Арт. № Item №	Баркод Barcode			
99678	3800154047466	1/10		



-  **» Всеки комплект съдържа:**
All sets include:
NEOPERL водоспестяващи аератори
NEOPERL water saving aerators
SEDAL керамичен затварящ механизъм
SEDAL ceramic cartage
TUCAI гъвкави връзки
TUCAI flexible hoses
Монтажен комплект :
Mounting kit
Витло (където е указано със снимка)
POP-UP (when is on the picture)
Луксозна кутия
luxury box
Гаранционна карта
Warranty card



THS[®]
THERMOSTYLE



МЕСИНГОВИ СМЕСИТЕЛИ BRASS MIXERS

ЕДНОРЪКОВИ СМЕСИТЕЛИ СЕРИЯ АКВАРИУС СЪС ЗАТВАРЯЩ МЕХАНИЗЪМ Ø 40 THS by SEDAL BATHTUB MIXERS SINGLE HANDLE AQUARIUS SERIES WITH CERAMIC CARTAGE Ø 40 THS by SEDAL





СМЕСИТЕЛ ЗА ВАНА АКВАРИУС
BATHTUB MIXER FAUCET AQUARIUS



Размер Dimension	Арт. № Item №	Баркод Barcode			
Ø 40	8900	3800154016097	1/12		

СМЕСИТЕЛ ЗА МИВКА СТОЯЩ ЗА БАНЯ АКВАРИУС
AQUARIUS BATHROOM DECK-MOUNT SINK MIXER FAUCET



Размер Dimension	Арт. № Item №	Баркод Barcode			
Ø 40	830	3800154016141	1/12		



СМЕСИТЕЛ ЗА МИВКА СТЕНЕН АКВАРИУС
WALL-MOUNT SINK MIXER FAUCET AQUARIUS



Размер Dimension	Арт. № Item №	Баркод Barcode			
Ø 40 16 cm spout	8901	3800154016103	1/12		
Ø 40 18 cm spout	8902	3800154016110	1/12		
Ø 40 22 cm spout	8903	3800154016127	1/12		

СМЕСИТЕЛ ЗА КУХНЯ СТОЯЩ АКВАРИУС
DECK-MOUNT KITCHEN MIXER FAUCET AQUARIUS



Размер Dimension	Арт. № Item №	Баркод Barcode			
Ø 40	99670	3800154047329	1/10		

СМЕСИТЕЛ ЗА КУХНЯ АКВАРИУС
DECK-MOUNT KITCHEN MIXER FAUCET AQUARIUS

10249







888



Размер Dimension	Арт. № Item №	Баркод Barcode			
Ø 40	888	3800154016134	1/12		
Ø 40	10249	3800154041488	1/12		

СМЕСИТЕЛ ЗА КУХНЯ СТОЯЩ АКВАРИУС
DECK-MOUNT KITCHEN MIXER FAUCET AQUARIUS



Размер Dimension	Арт. № Item №	Баркод Barcode			
Ø 40	8904	3800154016158	1/12		

МЕДИНИ СМЕСИТЕЛИ BRASS MIXERS

ДВУРЪКОХВАТКОВИ СМЕСИТЕЛИ DOUBLE HANDLE FAUCETS

СМЕСИТЕЛ ЗА ВАНА ВИТА BRASS BATHTUB MIXER FAUCET VITA



Размер Dimension	Арт. № Item №	Баркод Barcode			
1/2"	8804	3800154016028	1/12		

СМЕСИТЕЛ ЗА МИВКА ВИТА BRASS FAUCET DOUBLE HANDLE VITA



Вид Type	Арт. № Item №	Баркод Barcode			
R ЛЕБЕДКА/ R SPOUT	8806	3800154016035	1/12		
U ЛЕБЕДКА/ U SPOUT	8807	3800154016042	1/12		
S ЛЕБЕДКА/ S SPOUT	8808	3800154016059	1/12		
L ЛЕБЕДКА/ L SPOUT	8809	3800154016066	1/12		

СМЕСИТЕЛ ЗА МИВКА ВИТА BRASS FAUCET DOUBLE HANDLE VITA



Вид Type	Арт. № Item №	Баркод Barcode			
16 см	991052	3800154040801	1/12		
18 см	991054	3800154041532	1/12		
22 см	991059	3800154040849	1/12		

СМЕСИТЕЛ ЗА МИВКА С ЧУПЕЦА ЛЕБЕДКА ВИТА BRASS FAUCET-FLEXIBLE SPOUT VITA



Размер Dimension	Арт. № Item №	Баркод Barcode			
	991050	3800154041549	1/12		

СМЕСИТЕЛ ЗА ВАНА ДАЛИЯ BRASS BATHTUB MIXER FAUCET DALIA



Размер Dimension	Арт. № Item №	Баркод Barcode			
1/2"	8814	3800154015977	1/12		

СМЕСИТЕЛ ЗА МИВКА ДАЛИЯ BRASS FAUCET DOUBLE HANDLE DALIA



Вид Type	Арт. № Item №	Баркод Barcode			
R ЛЕБЕДКА/ R SPOUT	8810	3800154015984	1/12		
U ЛЕБЕДКА/ U SPOUT	8811	3800154015991	1/12		
S ЛЕБЕДКА/ S SPOUT	8812	3800154016004	1/12		
L ЛЕБЕДКА/ L SPOUT	8813	3800154016011	1/12		

THS[®]
THERMOSTYLE



МЕДИНГОВИ СМЕСИТЕЛИ BRASS MIXERS

СМЕСИТЕЛ ЗА МИВКА ДАЛИЯ BRASS FAUCET DOUBLE HANDLE DALIA



Вид Type	Арт. № Item №	Баркод Barcode			
16 см	991051	3800154040795			
18 см	991053	3800154040818			
22 см	991058	3800154040832			



СМЕСИТЕЛ ЗА ВАНА РЕТРО BATHTUB MIXER FAUCET RETRO



Размер Dimension	Арт. № Item №	Баркод Barcode			
	87	3800154027222			

СМЕСИТЕЛ ЗА ВАНА ИСКЪР БЯЛА BRASS BATHTUB MIXER FAUCET ISKAR WHITE



Размер Dimension	Арт. № Item №	Баркод Barcode			
	99101	3800154040597			

СМЕСИТЕЛ ЗА МИВКА С ЧУПЕЦА ЛЕБЕДКА ДАЛИЯ BRASS FAUCET-FLEXIBLE SPOUT DALIA



Размер Dimension	Арт. № Item №	Баркод Barcode			
	991049	3800154041457			

СМЕСИТЕЛ ЗА МИВКА РЕТРО BRASS FAUCET DOUBLE HANDLE RETRO



Вид Type	Арт. № Item №	Баркод Barcode			
Р ЛЕБЕДКА/ R SPOUT	8114	3800154015915			
U ЛЕБЕДКА/ U SPOUT	8115	3800154015922			
S ЛЕБЕДКА/ S SPOUT	8118	3800154015946			
L ЛЕБЕДКА/ L SPOUT	8117	3800154015939			

СМЕСИТЕЛ ЗА МИВКА ИСКЪР БЯЛА BRASS FAUCET DOUBLE HANDLE ISKAR WHITE



Вид Type	Арт. № Item №	Баркод Barcode			
Р ЛЕБЕДКА/ R SPOUT	99103	3800154040603			
U ЛЕБЕДКА/ U SPOUT	99102	3800154040610			
S ЛЕБЕДКА/ S SPOUT	99105	3800154040627			
L ЛЕБЕДКА/ L SPOUT	99104	3800154040634			

МЕДИНИ СМЕСИТЕЛИ BRASS MIXERS

СМЕСИТЕЛ ЗА МИВКА ИСКЪР БЯЛА BRASS FAUCET DOUBLE HANDLE ISKAR WHITE



Вид Type	Арт. № Item №	Баркод Barcode			
16 см	99106	3800154040658	1/12	<input checked="" type="checkbox"/>	<input checked="" type="checkbox"/>
18 см	99107	3800154040665	1/12	<input checked="" type="checkbox"/>	<input checked="" type="checkbox"/>
22 см	99108	3800154040672	1/12	<input checked="" type="checkbox"/>	<input checked="" type="checkbox"/>

СМЕСИТЕЛ ЗА МИВКА С ЧУПЕЦА ЛЕБЕДКА ИСКЪР BRASS FAUCET-FLEXIBLE SPOUT ISKAR WHITE



Размер Dimension	Арт. № Item №	Баркод Barcode			
	991055	3800154040641	1/12	<input checked="" type="checkbox"/>	<input checked="" type="checkbox"/>

СМЕСИТЕЛ ЗА ВАНА ИСКЪР ХРОМ BRASS BATHTUB MIXER FAUCET ISKAR CHROME



Размер Dimension	Арт. № Item №	Баркод Barcode			
	991010	3800154040689	1/12	<input checked="" type="checkbox"/>	<input checked="" type="checkbox"/>

СМЕСИТЕЛ ЗА МИВКА ИСКЪР ХРОМ BRASS FAUCET DOUBLE HANDLE ISKAR CHROME

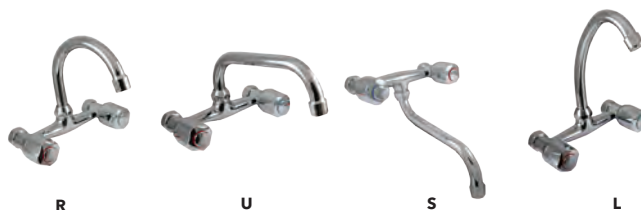

Вид Type	Арт. № Item №	Баркод Barcode			
R ЛЕБЕДКА/ R SPOUT	991012	3800154040696	1/12	<input checked="" type="checkbox"/>	<input checked="" type="checkbox"/>
U ЛЕБЕДКА/ U SPOUT	991016	3800154040702	1/12	<input checked="" type="checkbox"/>	<input checked="" type="checkbox"/>
S ЛЕБЕДКА/ S SPOUT	991015	3800154040719	1/12	<input checked="" type="checkbox"/>	<input checked="" type="checkbox"/>
L ЛЕБЕДКА/ L SPOUT	991011	3800154040726	1/12	<input type="checkbox"/>	<input type="checkbox"/>

СМЕСИТЕЛ ЗА МИВКА ИСКЪР ХРОМ BRASS FAUCET DOUBLE HANDLE ISKAR CHROME



Вид Type	Арт. № Item №	Баркод Barcode			
16 см	991017	3800154040740	1/12	<input checked="" type="checkbox"/>	<input checked="" type="checkbox"/>
18 см	991018	3800154040757	1/12	<input checked="" type="checkbox"/>	<input checked="" type="checkbox"/>
22 см	991019	3800154040764	1/12	<input type="checkbox"/>	<input type="checkbox"/>

СМЕСИТЕЛ ЗА МИВКА С ЧУПЕЦА ЛЕБЕДКА ИСКЪР ХРОМ BRASS FAUCET-FLEXIBLE SPOUT ISKAR CHROME





Размер Dimension	Арт. № Item №	Баркод Barcode			
	991056	3800154040733	1/12	<input checked="" type="checkbox"/>	<input checked="" type="checkbox"/>

МЕДИНГОВИ СМЕСИТЕЛИ BRASS MIXERS



СМЕСИТЕЛ ЗА ВАНА РОСИЦА БЯЛ BATH SHOWER DOUBLE HANDLE FAUCET ROSITSA WHITE



Размер Dimension	Арт. № Item №	Баркод Barcode			
1/2"	8574	3800154032691	1/24		✓



СМЕСИТЕЛ ЗА МИВКА РОСИЦА БЯЛ BATH SHOWER DOUBLE HANDLE FAUCET ROSITSA WHITE



Вид Type	Арт. № Item №	Баркод Barcode			
Р ЛЕБЕДКА/ R SPOUT	8575	3800154032707	1/24		✓
У ЛЕБЕДКА/ U SPOUT	8576	3800154032714	1/24		✓
С ЛЕБЕДКА/ S SPOUT	8577	3800154032721	1/24		✓
Л ЛЕБЕДКА/ L SPOUT	8578	3800154032738	1/24		✓



СМЕСИТЕЛ ЗА ВАНА РОСИЦА ХРОМ BATH SHOWER DOUBLE HANDLE FAUCET ROSITSA CHROME



Размер Dimension	Арт. № Item №	Баркод Barcode			
1/2"	8579	3800154032745	1/24		✓

СМЕСИТЕЛ ЗА МИВКА РОСИЦА ХРОМ BATH SHOWER DOUBLE HANDLE FAUCET ROSITSA CHROME



Вид Type	Арт. № Item №	Баркод Barcode			
Р ЛЕБЕДКА/ R SPOUT	8580	3800154032752	1/24		✓
У ЛЕБЕДКА/ U SPOUT	8581	3800154032769	1/24		✓
С ЛЕБЕДКА/ S SPOUT	8582	3800154032776	1/24		✓
Л ЛЕБЕДКА/ L SPOUT	8583	3800154032783	1/24		✓

СМЕСИТЕЛ ЗА КУХНЯ СТОЯЩ С ДВЕ РЪКОХВАТКИ KITCHEN MIXER FAUCET



Вид Type	Арт. № Item №	Баркод Barcode			
Далия / Dalia	88131	3800154029646	1/12		✓
Вита / Vita	88091	3800154029431	1/12		✓

СМЕСИТЕЛ ЗА КУХНЯ СТОЯЩ С ЕДНА РЪКОХВАТКА KITCHEN MIXER FAUCET



Вид Type	Арт. № Item №	Баркод Barcode			
Далия / Dalia	7512	3800154029554	1/12		✓
Вита / Vita	7513	3800154029561	1/12		✓

МЕДИНГОВИ СМЕСИТЕЛИ BRASS MIXERS

СПИРАТЕЛЕН КРАН ТИП КАНЕЛА STOP VALVE



Размер Dimension	Арт. № Item №	Баркод Barcode			
1/2" * 3/4"	8308	3800154032257	1/50		

КАНЕЛА СМЕСИТЕЛ У ЛЕБЕДКА С ВОДОСПЕСТЯВАЩ АЕРАТОР BRASS MIXER FAUCET WITH SPOUT U



Вид Type	Арт. № Item №	Баркод Barcode			
Далия / Dalia	7510	3800154029547	1/20		
Вита / Vita	7511	3800154029530	1/20		

ЮНГА СМЕСИТЕЛ - ЕДНОРЪКОХВАТКОВ СЪС ЗАТВАРЯЩ МЕХАНИЗЪМ THS by SEDAL UNGA BRASS MIXER FAUCET SINGLE HANDLE THS by SEDAL



Размер Dimension	Арт. № Item №	Баркод Barcode			
Ø 35 THS by Sedal	7519	3800154029615	1/12		

ЮНГА СМЕСИТЕЛ - ДВУРЪКОХВАТКОВ UNGA BRASS MIXER FAUCET TWO HANDLES



Размер Dimension	Арт. № Item №	Баркод Barcode			
3/8"	7518	3800154029608	1/12		



» Всеки комплект съдържа:

All sets include:

Водоспестяващи аератори

Water saving aerators

SEDAL Керамичен затварящ механизъм (СЕРИЯ АКВАРИУС)

SEDAL Ceramic cartage (SERIE AQARIUS)

Гъвкави връзки

Flexible hoses

Монтажен комплект :

Mounting kit

Витло (където е указано със снимка)

POP-UP (when is on the picture)

Гаранционна карта

Warranty card



THS[®]
THERMOSTYLE



ПРИНАДЛЕЖНОСТИ ЗА СМЕСИТЕЛИ ACCESSORIES FOR MIXERS

КЕРАМИЧЕН ЗАТВАРЯЩ МЕХАНИЗЪМ С КРАЧЕТА THS by SEDAL CERAMIC CARTAGE WITH LEGS THS by SEDAL



Размер Dimension	Арт. № Item №	Баркод Barcode			
Ø 35	6710	3800154027147	1/100		✓
Ø 40	6712	3800154027161	1/100		✓

ЗАТВАРЯЩ МЕХАНИЗЪМ BRASS CARTAGE



Размер Dimension	Арт. № Item №	Баркод Barcode			
3/8"	92	3800154028304	10/500		✗

ЗАТВАРЯЩ МЕХАНИЗЪМ BRASS CARTAGE



Размер Dimension	Арт. № Item №	Баркод Barcode			
1/2"	91	3800154014178	1/500		✓
1/2"	91091	3800154029448	10/250		✗

ЗАТВАРЯЩ МЕХАНИЗЪМ РЕТРО BRASS CARTAGE RETRO



Размер Dimension	Арт. № Item №	Баркод Barcode			
1/2"	9187	3800154016400	1/250		✓

КЕРАМИЧЕН ЗАТВАРЯЩ МЕХАНИЗЪМ БЕЗ КРАЧЕТА THS by SEDAL CERAMIC CARTAGE WITHOUT LEGS THS by SEDAL



Размер Dimension	Арт. № Item №	Баркод Barcode			
Ø 35	6711	3800154027154	1/200		✓
Ø 40	6713	3800154027178	1/100		✓

ЗАТВАРЯЩ МЕХАНИЗЪМ КЕРАМИЧЕН BRASS CARTAGE TIK TAK



Размер Dimension	Арт. № Item №	Баркод Barcode			
1/2"	995	3800154014161	1/250		✓
1/2"	910995	3800154029455	10/250		✗

ЗАТВАРЯЩ МЕХАНИЗЪМ ЦЯЛА ГУМА BRASS CARTAGE WITH WHOLE BLACK RUBBER



Размер Dimension	Арт. № Item №	Баркод Barcode			
1/2"	9111	3800154021183	1/500		✓
1/2"	9109111	3800154029462	10/500		✗



THS[®]
THERMOSTYLE



ПРИНАДЛЕЖНОСТИ ЗА СМЕСИТЕЛИ ACCESSORIES FOR MIXERS

РЪКОХВАТКА РЕТРО КОМПЛЕКТ 2 БРОЯ METAL HANDLE RETRO 2 PCS



Размер Dimension	Арт. № Item №	Баркод Barcode			
1/2"	6765	3800154028328			✓

РЪКОХВАТКА РЕТРО METAL HANDLE RETRO



Размер Dimension	Арт. № Item №	Баркод Barcode			
1/2"	989	3800154014338			✓

РЪКОХВАТКА ВИТА КОМПЛЕКТ 2 БРОЯ METAL HANDLE VITA 2 PCS



Размер Dimension	Арт. № Item №	Баркод Barcode			
1/2"	6764	3800154028335			✓

РЪКОХВАТКА ВИТА METAL HANDLE VITA



Размер Dimension	Арт. № Item №	Баркод Barcode			
1/2"	996	3800154014239			✗

РЪКОХВАТКА ДАЛИЯ КОМПЛЕКТ 2 БР. PLASTIC HANDLE DALIA 2 PCS



Размер Dimension	Арт. № Item №	Баркод Barcode			
1/2"	6716	3800154027208			✓

РЪКОХВАТКА ДАЛИЯ PLASTIC HANDLE DALIA



Размер Dimension	Арт. № Item №	Баркод Barcode			
1/2"	96	3800154014208			✗

РЪКОХВАТКА ЕЛИ PLASTIC HANDLE ELI



Размер Dimension	Арт. № Item №	Баркод Barcode			
3/8"	93	3800154028311			✗

ПРИНАДЛЕЖНОСТИ ЗА СМЕСИТЕЛИ

ACCESSORIES FOR MIXERS

КОМПЛЕКТ ЗАТВАРЯЩ МЕХАНИЗЪМ С РЪКОХВАТКА ЕЛИ
SET BRASS CARTAGE WITH HANDLE ELI



Размер Dimension	Арт. № Item №	Баркод Barcode			
3/8"	9293	3800154014185	1/50		

КОМПЛЕКТ ЗАТВАРЯЩ МЕХАНИЗЪМ С РЪКОХВАТКА ДАЛИЯ
SET BRASS CARTAGE WITH HANDLE DALIA



Размер Dimension	Арт. № Item №	Баркод Barcode			
1/2"	6766	3800154028359	1/125		

КОМПЛЕКТ ЗАТВАРЯЩ МЕХАНИЗЪМ С РЪКОХВАТКА ВИТА
SET BRASS CARTAGE WITH HANDLE VITA



Размер Dimension	Арт. № Item №	Баркод Barcode			
1/2"	6767	3800154028342	1/50		

КОМПЛЕКТ ЗАТВАРЯЩ МЕХАНИЗЪМ РЕТРО С РЪКОХВАТКА РЕТРО
SET BRASS CARTAGE RETRO WITH HANDLE RETRO



Размер Dimension	Арт. № Item №	Баркод Barcode			
1/2"	6768	3800154028366	1/50		

КОМПЛЕКТ ЗАТВАРЯЩ МЕХАНИЗЪМ С РЪКОХВАТКА ТИП ЮНГА
SET WITH CARTAGE AND PLASTIC HANDLE TRIANGLE FOR UNGA



Размер Dimension	Арт. № Item №	Баркод Barcode			
3/8"	7520	3800154029622	1/50		

TMS[®]
THERMOSTYLE



ПРИНАДЛЕЖНОСТИ ЗА СМЕСИТЕЛИ ACCESSORIES FOR MIXERS

КОМПЛЕКТ ЗАТВАРЯЩ МЕХАНИЗЪМ С РЪКОХВАТКА АБМ ХРОМ SET ABM CHROME



9192

9191



Размер Dimension	Арт. № Item №	Баркод Barcode			
1/2"	9192	3800154034923	1/250		
1/2"	9191	3800154034916	1/250		

КОМПЛЕКТ ЗАТВАРЯЩ МЕХАНИЗЪМ С РЪКОХВАТКА АБМ БЯЛ SET ABM WHITE



9190

9189



Размер Dimension	Арт. № Item №	Баркод Barcode			
1/2"	9190	3800154034909	1/250		
1/2"	9189	3800154034893	10/250		

КОМПЛЕКТ ЗАТВАРЯЩ МЕХАНИЗЪМ С РЪКОХВАТКА РОСИЦА ХРОМ SET ROSITSA CHROME



9196

9195



Размер Dimension	Арт. № Item №	Баркод Barcode			
1/2"	9195	3800154034954	1/250		
1/2"	9196	3800154034961	1/250		

КОМПЛЕКТ ЗАТВАРЯЩ МЕХАНИЗЪМ С РЪКОХВАТКА РОСИЦА БЯЛ SET ROSITSA WHITE



9194

9193



Размер Dimension	Арт. № Item №	Баркод Barcode			
1/2"	9193	3800154034930	1/50		
1/2"	9194	3800154034947	1/50		

КОМПЛЕКТ ЗАТВАРЯЩ МЕХАНИЗЪМ С РЪКОХВАТКА ИСКЪР ХРОМ SET ISKAR CHROME



9200

9199



Размер Dimension	Арт. № Item №	Баркод Barcode			
1/2"	9200	3800154035005	1/250		
1/2"	9199	3800154034992	1/250		

КОМПЛЕКТ ЗАТВАРЯЩ МЕХАНИЗЪМ С РЪКОХВАТКА ИСКЪР БЯЛ SET ISKAR WHITE



9198

9197



Размер Dimension	Арт. № Item №	Баркод Barcode			
1/2"	9197	3800154034978	1/250		
1/2"	9198	3800154034985	1/250		

ПРИНАДЛЕЖНОСТИ ЗА СМЕСИТЕЛИ

ACCESSORIES FOR MIXERS

МОНТАЖЕН КОМПЛЕКТ МЕСИНГ ЗА СТОЯЩ СМЕСИТЕЛ

SCREW, O-RING, RUBBER WASHER, BRASS



Размер Dimension	Арт. № Item №	Баркод Barcode			
1 отвор/ 1 hole	7508	3800154029523			
2 отвора/ 2 holes	7509	3800154029516			

ЛЕГЛО ЗА СМЕСИТЕЛ

SS BED FOR FAUCET



Размер Dimension	Арт. № Item №	Баркод Barcode			
	992	3800154016264			

ГАЙКА ЗА СМЕСИТЕЛ МЕСИНГ ХРОМ

BRASS NUT FOR FAUCET



Размер Dimension	Арт. № Item №	Баркод Barcode			
3/4"	914	3800154014468			

ВОДОСПЕСТЯВАЩ АЕРАТОР ЗА ЛЕБЕДКА

WATERSAVING AERATOR



6714

6715

Размер Dimension	Арт. № Item №	Баркод Barcode			
Ø 22 mm	6714	3800154027185			
Ø 24 mm	6715	3800154027192			

ЕКСЦЕНТРИК ЗА СМЕСИТЕЛ МЕСИНГ

BRASS ELBOW FOR FAUCET



Размер Dimension	Арт. № Item №	Баркод Barcode			
3/4" * 1/2"	928	3800154014437			

РОЗЕТКА МЕСИНГ ХРОМ

ROSETTE BRASS CHROME PLATED



Размер Dimension	Арт. № Item №	Баркод Barcode			
3/4"	9271	3800154014444			

РОЗЕТКА ЗА РЪКОХВАТКА РЕТРО

COVER FOR HANDLE RETRO



Размер Dimension	Арт. № Item №	Баркод Barcode			
	7245	3800154029486			

TMS[®]
THERMOSTYLE



ПРИНАДЛЕЖНОСТИ ЗА СМЕСИТЕЛИ ACCESSORIES FOR MIXERS

УНИВЕРСАЛНА ЧУПЕЦА СЕ ГЪВКАВА ЛЕБЕДКА, КОМПЛЕКТ С ДУШЧЕ РАЗПРЪСКВАЧ FLEXIBLE SPOUT



Размер Dimension	Арт. № Item №	Баркод Barcode			
3/4"	993	3800154016561	1/50		

ДУШЧЕ РАЗПРЪСКВАЧ ЗА ЛЕБЕДКА SPREADING SHOWER FOR SPOUT



Размер Dimension	Арт. № Item №	Баркод Barcode			
	6717	3800154027215	1/250		

СЛУШАЛКА ЗА ДУШ SHOWER, HEAVY TYPE



Вид Type:	Арт. № Item №	Баркод Barcode			
Ретро / Retro	912	3800154029479	1/100		
Антиваровик / Anti Limestone	9910	3800154018695	1/50		

ЛЕБЕДКА ЗА СМЕСИТЕЛ С ВОДОСПЕСТЯВАЩ АЕРАТОР BRASS SPOUT FOR FAUCET AND WATERSAVING AERATOR



Размер Dimension	Арт. № Item №	Баркод Barcode			
35 cm	99665	3800154047220	1/100		
40 cm	99666	3800154047237	1/100		

ЛЕБЕДКА ЗА СМЕСИТЕЛ С ВОДОСПЕСТЯВАЩ АЕРАТОР STAINLESS SPOUT WITH WATER SAVING AERATOR



Размер Dimension	Арт. № Item №	Баркод Barcode			
R ЛЕБЕДКА/ R SPOUT	9640	3800154029578	1/200		
U ЛЕБЕДКА/ U SPOUT	9660	3800154029585	1/200		
S ЛЕБЕДКА/ S SPOUT	9650	3800154029592	1/200		
L ЛЕБЕДКА/ L SPOUT	9670	3800154029639	1/200		
ЗА ЮНГА	9671	3800154032264	1/100		

ЛЕБЕДКА ЗА СМЕСИТЕЛ АКВАРИУС С ВОДОСПЕСТЯВАЩ АЕРАТОР BRASS SPOUT FOR AQUARIUS FAUCET AND WATERSAVING AERATOR



Размер Dimension	Арт. № Item №	Баркод Barcode			
16 cm	99316	3800154016172	1/100		
18 cm	99318	3800154016189	1/100		
22 cm	99322	3800154016196	1/100		

ТЕХНИЧЕСКИ ПАРАМЕТРИ:

Външен диаметър 14 mm
Вътрешен диаметър 7.5 mm
Вътрешен диаметър на присъединителния фитинг 6 mm

Дебит-20-30 л/мин. при налягане 3 бара
Работно налягане: 10 бара
Работна температура: 70°C
ANTI-TWIST функция - подвижният накрайник не позволява усукване на шлауха

МАТЕРИАЛИ:

Накрайници - месинг хромиран
Оплетка - неръждаема стомана
Сърцевина на оплетката - EPDM

TECHNICAL DATA:

Outer diameter 14 mm
Inner diameter 7.5 mm
Fitting inner diameter 6 mm

Flow rate-20-30 l/min at 3 bars
Working pressure: 10 bars
Working temperature: 70°C
ANTI-TWIST function - the conical nut G 1/2" anti-twist do not allow the hose to be twisted

MATERIALS:

Fittings - brass chrome plated
Braid of the hose- stainless steel
Inner material of the hose - EPDM

ШЛАУХИ SHOWER HOSES

ШЛАУХ РАЗТЕГАТЕЛЕН ANTI-TWIST GOLD SHOWER HOSE EXTENDABLE ANTI-TWIST GOLD



ANTI-TWIST
360°

Размер Dimension	Арт. № Item №	Баркод Barcode		
1/2" - 120-150 cm	6836	3800154028649	1/25	<input checked="" type="checkbox"/>

ШЛАУХ РАЗТЕГАТЕЛЕН ANTI-TWIST SILVER SHOWER HOSE EXTENDABLE ANTI-TWIST SILVER



ANTI-TWIST
360°

Размер Dimension	Арт. № Item №	Баркод Barcode		
1/2" - 175-220 cm	6835	3800154028632	1/25	<input checked="" type="checkbox"/>

ШЛАУХ PVC ANTI-TWIST BLACK SHOWER TUBE PVC ANTITWIST BLACK



Размер Dimension	Арт. № Item №	Баркод Barcode		
1/2" - 175 cm	7728	3800154031359	1/25	<input checked="" type="checkbox"/>
1/2" - 120 cm	9165	3800154037702	1/25	<input checked="" type="checkbox"/>

ШЛАУХ PVC ANTI-TWIST GOLD SHOWER TUBE PVC ANTITWIST GOLD



Размер Dimension	Арт. № Item №	Баркод Barcode		
1/2" - 175 cm	7726	3800154031342	1/25	<input checked="" type="checkbox"/>

ШЛАУХ PVC ANTI-TWIST SILVER SHOWER TUBE PVC ANTITWIST SILVER



Размер Dimension	Арт. № Item №	Баркод Barcode		
1/2" - 175 cm	7725	3800154031335	1/25	<input checked="" type="checkbox"/>
1/2" - 120 cm	9166	3800154037719	1/25	<input checked="" type="checkbox"/>

РАЗРЕДИТЕЛ ЗА ДУШ МЕСИНГ ХРОМ DIVERTER BRASS CHROME PLATED



Размер Dimension	Арт. № Item №	Баркод Barcode		
3/4"	958	3800154014369	1/100	<input checked="" type="checkbox"/>

TMS[®]
THERMOSTYLE



СИФОНИ DRAINERS

СИФОН ЗА МИВКА НЕРЪЖДАЕМ БЕЗ ВИТЛО BOTTLE ROUND TRAP WITHOUT POP UP



Размер Dimension	Арт. № Item №	Баркод Barcode			
1 1/4"	9996	3800154040498	1/25		

СИФОН ЗА МИВКА НЕРЪЖДАЕМ БЕЗ ВИТЛО BOTTLE ROUND TRAP WITHOUT POP UP



Размер Dimension	Арт. № Item №	Баркод Barcode			
1 1/4"	9998	3800154040511	1/25		

СИФОН ЗА МИВКА НЕРЪЖДАЕМ С ВИТЛО BOTTLE ROUND TRAP WITH BRASS TAP



Размер Dimension	Арт. № Item №	Баркод Barcode			
1 1/4"	1067	3800154013423	1/25		

СИФОН ЗА МИВКА НЕРЪЖДАЕМ БЕЗ ВИТЛО BOTTLE ROUND TRAP WITHOUT POP UP



Размер Dimension	Арт. № Item №	Баркод Barcode			
1 1/4"	9997	3800154040504	1/25		

ВИТЛО КЛИК ЗА МИВКА МЕСИНГ BRASS TIK TAK TAP FOR SINK

1069 9942 99421 10691



Размер Dimension	Арт. № Item №	Баркод Barcode			
1 1/4"	1069	3800154016806	1/45		
1 1/4"	10692	3800154004131	1/45		
1 1/4" 68/68мм	9942	3800154040481	1/45		
1 1/4" 68/68мм	99421	3800154004148	1/45		

ГОФРИРАНА ВРЪЗКА НЕРЪЖДАВЕЙКА ХРОМ METAL TUBE SS



Размер Dimension	Арт. № Item №	Баркод Barcode			
1 1/4"	10531	3800154016790	1/50		



СИФОНИ DRAINERS

ПОДОВ СИФОН С КЛАПА СЕРИЯ BLACKMATT BOTTLE ROUND TRAP WITHOUT POP UP



Размер Dimension	Арт. № Item №	Баркод Barcode			
100*100 mm/ Ø 50	9971	3800154004278	1/40		

ПОДОВ СИФОН С КЛАПА СЕРИЯ RAINBOW BOTTLE SQUARED TRAP WITHOUT POP UP

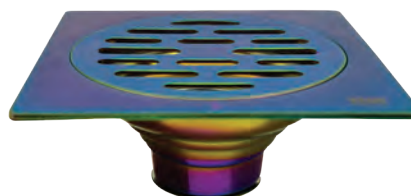

Размер Dimension	Арт. № Item №	Баркод Barcode			
100*100 mm/ Ø 50	99613	3800154004193	1/40		

СИФОН РОГОВ МЕСИНГ ХРОМ КВАДРАТ BRASS COVERED FLOOR ANGLE DRAIN

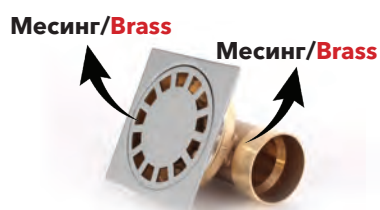

Размер Dimension	Арт. № Item №	Баркод Barcode			
100*100 mm/ Ø 50	1082	3800154013829	1/50		

СИФОН ПРАВ МЕСИНГ КВАДРАТ BRASS FLOOR STRAIGHT DRAIN

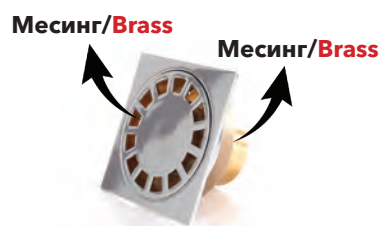

Размер Dimension	Арт. № Item №	Баркод Barcode			
100*100 mm/ Ø 50	100333	3800154016783	1/50		

ТАПА ЗА МИВКА COVER TAP DECORATIVE FOR SINK



7912

791



Размер Dimension	Арт. № Item №	Баркод Barcode			
	7912	3800154013492	10/200		
	791	3800154013485	10/200		

ВИТЛО МЕСИНГОВО BRASS TAP FOR SINK



Размер Dimension	Арт. № Item №	Баркод Barcode			
1 1/4"	108	3800154013430	1/100		
1 1/2"	10812	3800154016417	1/100		

TMS
THERMOSTYLE



ТЕФЛОНИ И КЪЛЧИЦА PTFE AND HACKLED FLAX

ТЕФЛОНОВА ЛЕНТА ЖЪЛТА ЗА ГАЗ ПРОФЕСИОНАЛНА PTFE YELLOW TAPE



Размер Dimension	Арт. № Item N°	Баркод Barcode			
12mm*0,1mm*12 meters	5781	3800154022258	10/200		✓
19mm*0,2mm*15 meters±	5782	3800154022265	10/80		✓
25mm*0,1mm*50 meters	5783	3800154022272	10/80		✓

ТЕФЛОНОВ КОНЕЦ PTFE



Размер Dimension	Арт. № Item N°	Баркод Barcode			
80 метра/meters	6100	3800154022432	24/120		✓
150 метра/meters	6101	3800154022449	20/100		✓

ТЕЧЕН ТЕФЛОН LIQUID PTFE



Размер Dimension	Арт. № Item N°	Баркод Barcode			
50 ml	6102	3800154022456	10/100		✓
250 ml	6103	3800154022463	10/60		✓

КЪЛЧИЦА HACKLED FLAX (HAMP)



Тегло Weight	Арт. № Item N°	Баркод Barcode			
±60 гр./g.	478	3800154002465	1/700		✓
±100 гр./g.	4782	3800154024122	1/350		✓
± 200 гр./g.	4784	3800154032561	1/350		✓
± 250 гр./g.	4785	3800154032578	1/350		✓
± 40 гр./g.	4786	3800154032585	1/300		✓
± 80 гр./g.	4783	3800154024139	1/192		✓

НОЖИЦА ЗА ППР АВТОМАТИК CUTTER FOR PPR AUTOMATIC



Размер Dimension	Арт. № Item N°	Баркод Barcode			
Ø 20 - Ø 42	94500	3800154019357	1/50		✓

КЪЛЧИЦА БАЛА 50 кг HACKLED FLAX (HAMP) MOQ 50 kg



Тегло Weight	Арт. № Item N°	Баркод Barcode			
50 kg	4781		1/50		✗

ОТОПЛЕНИЕ
HEATING





ПРЕДИМСТВА НА АЛУМИНИЕВИТЕ ЛИРИ ЗА БАНЯ



ADVANTAGES OF ALUMINIUM RADIATORS FOR BATHROOM



100 % Алуминий

Алуминият не корозира;
Във вътрешността на лирата не се наслагват ръжди и утайки;
Не се образува ръжда върху видимата външна част на лирата;
Водата в лирата остава чиста.

Висока степен на топлоотдаване

Липсата на образувани наслагвания вътре в лирата спомага за нейната по-голяма енергийна ефективност.

Издържат на високо работно налягане PN 16

12 години продуктова гаранция

Екологично чист продукт

За изработката се използва рециклиран материал.

Удобни и лесни за монтаж и транспортиране

За разлика от други метали, алуминият е лек, което позволява лирата за баня THERMOSTYLE да бъде удобна за монтаж и транспортиране.

Произведено в Европейски съюз

Комплектът съдържа:

Крепежни елементи;
Ръчен обезвъздушител;
Хром-месинг тапа с уплътнение 1/2".

100 % Aluminium

Aluminum does not corrode;
No formation of rust and sludge inside the radiators;
No formation of rust and external corrosion;
Always clean water system.

High heat capacity

Absence of radishes and sludge inside radiators help for greater energy efficiency.

High working pressure resistant PN16

12 years product warranty

Ecologically friendly product

Only recycled metal is used for the product.

Comfortable and easy to install and transport

Unlike other metals, aluminium is light, which allows the aluminium radiators THERMOSTYLE to be comfortable for installation and transportation.

Made in European Union

The set contains:

Fasteners;
Manual air vent;
End cap brass chrome plated with a seal 1/2".



CAYMAN

АЛУМИНИЕВИ ЛИРИ



Арт. № Item N°	Баркод Barcode		L- Габарит на лирата/ Width/mm	H-Височина на лирата/ Height/mm	N-Междусие на лирата/ Centre distance/mm	Водно съдържание/ Water content/L	Watt/ A°/h°	Watt/ A°/h°	Цвят/ Color
6839	3800154028670	✓	432	600	400	2.65	286	352	Бял/White
6840	3800154028687	✓	432	900	400	2.80	378	465	Бял/White
6841	3800154028694	✓	432	900	400	2.80	378	465	Пясъчно сиво/Sandy grey
6842	3800154028700	✓	432	900	400	2.80	378	465	Пясъчно черно/Sandy black
6843	3800154028717	✓	432	1200	400	4.10	572	704	Бял/White
6844	3800154028724	✓	432	1200	400	4.10	572	704	Пясъчно сиво/Sandy grey
6845	3800154028731	✓	432	1200	400	4.10	572	704	Пясъчно черно/Sandy black
6846	3800154028748	✓	432	1400	400	5.60	672	827	Бял/White
6847	3800154028755	✓	532	900	500	3.20	487	600	Бял/White
7631	3800154030291	✓	532	900	500	5.60	672	678	Пясъчно сиво/Sandy grey
7632	3800154030307	✓	532	900	500	5.30	672	678	Пясъчно черно/Sandy black
6848	3800154028762	✓	532	1200	500	4.50	677	834	Бял/White
7624	3800154030222	✓	532	1200	500	4.50	677	877	Пясъчно сиво/Sandy grey
7625	3800154030239	✓	532	1200	500	4.50	677	877	Пясъчно черно/Sandy black
7626	3800154030253	✓	632	1200	600	4.90	810	1052	Бял/White
7627	3800154030246	✓	632	1200	600	4.90	810	1052	Пясъчно сиво/Sandy grey
7628	3800154030260	✓	632	1200	600	4.90	810	1052	Пясъчно черно/Sandy black

СХЕМА ЗА МОНТАЖ INSTALLATION SCHEME

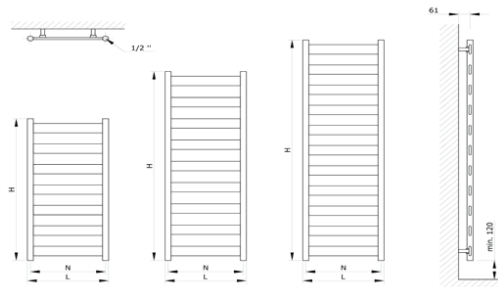



CLASSICA

АЛУМИНИЕВИ ЛИРИ



CHROME

BLACK

GOLD

ANTHRACITE

Арт. № Part N°	Баркод Barcode		L- Габарит на лирата/ Width/mm	H-Височина на лирата/ Height/mm	N-Междусие на лирата/ Centre distance/mm	Водно съдържание/ Water content/L	Watt/ ΔT50°	Watt/ ΔT40°	Цвят/ Color
99625	3800154046148	✓	400	900	368	3,00	374	426	Хром/Chrome
99793	3800154051203	✓	400	900	368	3,00	374	426	Антрацит/Anthracite
99626	3800154046155	✓	400	1200	368	4,40	483	594	Хром/Chrome
99794	3800154051210	✓	400	1200	368	4,40	483	594	Антрацит/Anthracite
99623	3800154046124	✓	500	800	468				Хром/Chrome
99795	3800154051227	✓	500	800	468				Антрацит/Anthracite
99699	3800154046162	✓	500	900	468	3,4	450	597	Gold cappuccino
99796	3800154051234	✓	500	1200	468	4,3	593	730	Антрацит/Anthracite
99624	3800154046131	✓	500	1200	468	4,3	593	730	Хром/Chrome

* Възможна опция за изпълнение на индивидуални поръчки по желание на клиента (цветове, размери)
We are able to execute individual orders for models according your specific requirements (different dimensions and colors and etc)





CLASSICA

АЛУМИНИЕВИ ЛИРИ

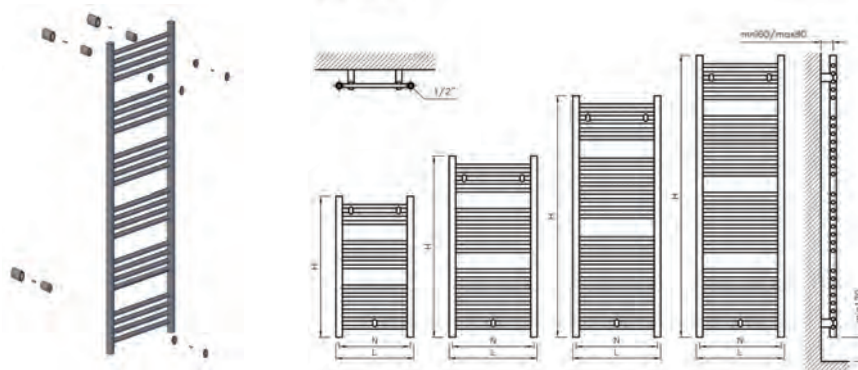

Арт. № Item N	Баркод Barcode	1	L- Габарит на лирата/ Width/mm	H- Височина на лирата/ Height/mm	N- Междусие на лирата/ Centre distance/mm	Водно съдържание/ Water content/L	Watt/ Δ150°	Watt/ Δ160°
6849	3800154028779	✓	400	900	368	3,00	347	426
6850	3800154028786	✓	400	1200	368	4,40	483	594
6851	3800154028793	✓	400	1400	368	5,10	620	762
6852	3800154028809	✓	400	1600	368	6,20	709	872
6853	3800154028816	✓	500	900	468	3,40	450	554
6854	3800154028823	✓	500	1200	468	4,30	593	730
6855	3800154028830	✓	500	1400	468	5,50	723	890
6856	3800154028847	✓	600	900	568	3,65	548	675
6857	3800154028854	✓	600	1200	568	4,90	701	863
6858	3800154028861	✓	600	1400	568	5,90	832	1024

ORBIT

АЛУМИНИЕВИ ЛИРИ



Арт. № Item N	Баркод Barcode	1	L- Габарит на лирата/ Width/mm	H- Височина на лирата/ Height/mm	N- Междусие на лирата/ Centre distance/mm	Водно съдържание/ Water content/L	Watt/ Δ150°	Watt/ Δ160°
6859	3800154028878	✓	432	900	400	4,10	334	554
6860	3800154028885	✓	432	1200	400	5,40	465	654
7629	3800154030277	✓	532	900	500	4,50	554	693
7630	3800154030284	✓	532	1200	500	5,90	631	820

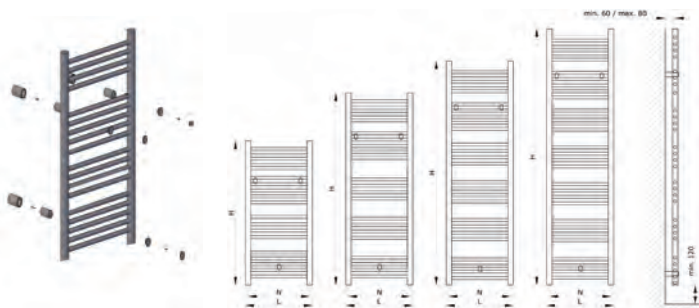

АЛУМИНИЕВИ ЕЛЕКТРИЧЕСКИ ЛИРИ ALUMINIUM ELECTRIC BATHROOM RADIATORS

THS[®] DESIGN RADIATOR
THERMOSTYLE **SOFIA**

МОДЕРЕН ДИЗАЙН

Модерен дизайн, високо качество и безопасност са характеристиките, които притежават електрическите лири SOFIA.

ПРАКТИЧНО РЕШЕНИЕ

Вградените практични сушилници в предната част на електрическата лира SOFIA са подходящи за сушене на малки хавлии или дрехи.

ВИСОКО КАЧЕСТВО

Електрическите лири SOFIA се използват самостоятелно без необходимост от вода или други отоплителни флуиди. По този начин възможността от замръзване на отоплителната система или повишаване на налягането в отоплителното тяло е напълно елиминирана.

БЕЗОПАСНО ЕЛЕКТРИЧЕСКО ОТОПЛЕНИЕ

Предната част на лирата е изработена от висококачествен алуминиев профил, който придава луксозен облик с елегантни линии. Електрическият нагревател е вграден в тръби от неръждаема стомана, които са свързани в солидна конструкция, позволяваща оптимално и равномерно нагряване на предните панели.

MODERN DESIGN

Modern design, high quality and safety are characteristics which recommend bathroom radiator SOFIA Electric.

PRACTICAL SOLUTION

Thanks to the usage of practical holders on the front surface, SOFIA Electric is also a dryer of towels and small clothing pieces.

HIGH QUALITY

The front part of the radiator is made of the high quality aluminum profiles, giving this radiator a luxury look and elegant lines. Electrical heater is integrated in the stainless steel tubes, which are connected into a solid construction enabling optimal and even heat expansion to the front panels.

SAFE ELECTRICAL HEATING

SOFIA Electric is a dry radiator not containing water nor other heating fluid. This way the possibility of freezing or pressure expansion inside the heating body is avoided.



АЛУМИНИЕВИ ЕЛЕКТРИЧЕСКИ ЛИРИ
ALUMINIUM ELECTRIC RADIATORS

THS[®] DESIGN RADIATOR
SOFIA



АЛУМИНИЕВА ЕЛЕКТРИЧЕСКА ЛИРА БЯЛА
ALUMINIUM ELECTRIC TOWEL RADIATOR WHITE

Арт. № Item N	Баркод Barcode	L- Габарит на лирата/ Width/mm	H- Височина на лирата/ Height/mm	Тегло/ Weight	Watt	Температурен диапазон/ Temperature control	Електро-захранване/ Power supply	1
7468	3800154029202	404	800	3.7	400	5÷85°C	220 - 240 V 50 Hz	✓
7469	3800154029219	404	1000	4.6	500	5÷85°C	220 - 240 V 50 Hz	✓
7470	3800154029226	558	800	5.6	600	5÷85°C	220 - 240 V 50 Hz	✓
7471	3800154029233	558	1000	6.9	750	5÷85°C	220 - 240 V 50 Hz	✓

БЯЛ СУШИЛНИК
WHITE HOLDER

IP 55



АЛУМИНИЕВА ЕЛЕКТРИЧЕСКА ЛИРА БЯЛА
ALUMINIUM ELECTRIC TOWEL RADIATOR WHITE

Арт. № Item N	Баркод Barcode	L- Габарит на лирата/ Width/mm	H- Височина на лирата/ Height/mm	Тегло/ Weight	Watt	Температурен диапазон/ Temperature control	Електро-захранване/ Power supply	1
7472	3800154029240	404	800	3.7	400	5÷85°C	220 - 240 V 50 Hz	✓
7473	3800154029257	404	1000	4.6	500	5÷85°C	220 - 240 V 50 Hz	✓
7474	3800154029264	558	800	5.6	600	5÷85°C	220 - 240 V 50 Hz	✓
7475	3800154029271	558	1000	6.9	750	5÷85°C	220 - 240 V 50 Hz	✓

ХРОМИРАН СУШИЛНИК
CHROME HOLDER

IP 55



THS[®]
THERMOSTYLE



ОТОПЛЕНИЕ HEATING

АЛУМИНИЕВИ ЕЛЕКТРИЧЕСКИ ЛИРИ ALUMINIUM ELECTRIC RADIATORS

THS[®] DESIGN RADIATOR
SOFIA

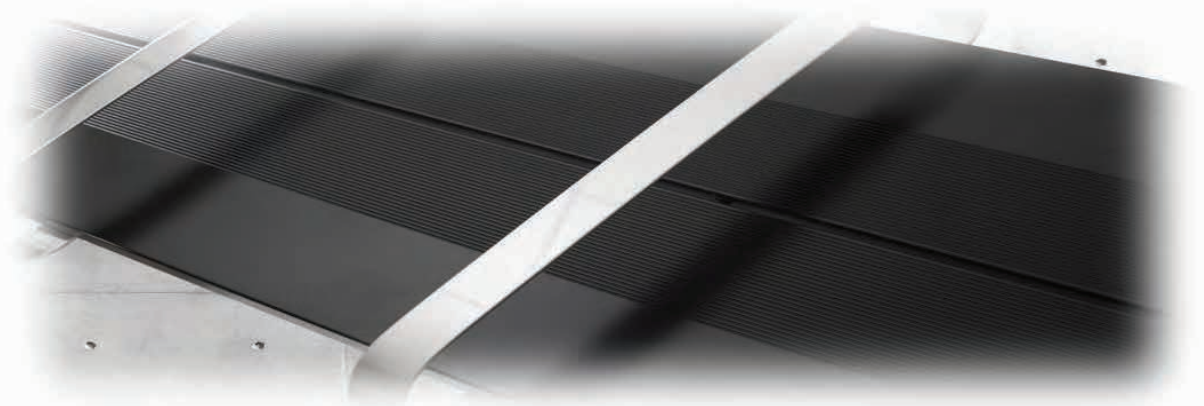

АЛУМИНИЕВА ЕЛЕКТРИЧЕСКА ЛИРА ЧЕРНА ALUMINIUM ELECTRIC TOWEL RADIATOR BLACK

Арт. № Item N	Баркод Barcode	L- Габарит на лирата/ Width/mm	H-Височина на лирата/ Height/mm	Тегло/ Weight	Watt	Температурен диапазон/ Temperature control	Електро-захранване/ Power supply	1
7480	3800154029325	404	800	3.7	400	5+85°C	220 - 240 V 50 Hz	✓
7481	3800154029332	404	1000	4.6	500	5+85°C	220 - 240 V 50 Hz	✓
7482	3800154029349	558	800	5.6	600	5+85°C	220 - 240 V 50 Hz	✓
7483	3800154029356	558	1000	6.9	750	5+85°C	220 - 240 V 50 Hz	✓

ХРОМИРАН СУШИЛНИК
CHROME HOLDER

IP 55



АЛУМИНИЕВА ЕЛЕКТРИЧЕСКА ЛИРА МЕТАЛИК ALUMINIUM ELECTRIC TOWEL RADIATOR METALIC

Арт. № Item N	Баркод Barcode	L- Габарит на лирата/ Width/mm	H-Височина на лирата/ Height/mm	Тегло/ Weight	Watt	Температурен диапазон/ Temperature control	Електро-захранване/ Power supply	1
7476	3800154029288	404	800	3.7	400	5+85°C	220 - 240 V 50 Hz	✓
7477	3800154029295	404	1000	4.6	500	5+85°C	220 - 240 V 50 Hz	✓
7478	3800154029301	558	800	5.6	600	5+85°C	220 - 240 V 50 Hz	✓
7479	3800154029318	558	1000	6.9	750	5+85°C	220 - 240 V 50 Hz	✓

ХРОМИРАН СУШИЛНИК
CHROME HOLDER

IP 55



THS[®]
THERMOSTYLE



**СТОМАНЕНА ЛИРА ОВАЛ
TOWEL RADIATOR FOR BATHROOM OVAL**

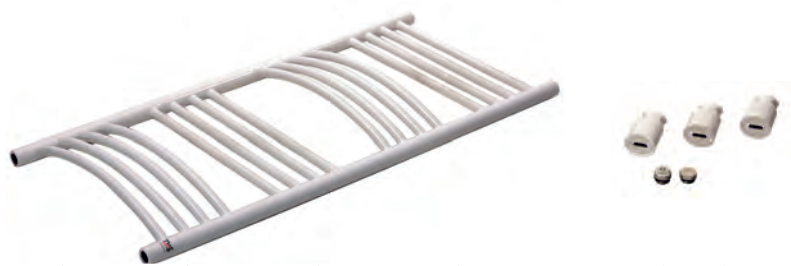

Арт. № Item N	Баркод Barcode		L- Габарит на лирата/Width/ mm	H-Височина на лирата/Height/mm	N-Междусие на лирата/ Centre distance/mm	Водно съдържание/ Water content/Lt.	Watt/ ΔT50°	Watt/ ΔT60°	Брой тръбички/ Qty of pipes Ø 22
27899	3800154028922		400	800	355	2,91	304	374	14
2790	3800154012167		400	900	355	3,35	334	411	15
27901	3800154028939		400	1000	355	3,48	360	443	16
2791	3800154012174		400	1200	355	4,26	442	544	20
2792	3800154012181		400	1400	355	4,83	498	613	22
279101	3800154032271		400	1600	355	5,40	505	606	24
2793	3800154012198		500	800	455	4,90	361	444	14
2794	3800154012204		500	1200	455	5,54	524	645	20
2795	3800154012211		500	1400	455	3,80	589	725	22
279102	3800154032288		500	1600	455	6,17	594	730	24
2796	3800154012228		600	800	555	4,50	492	606	14
2797	3800154012235		600	1200	555	5,54	607	747	20

**СТОМАНЕНА ЛИРА ПРАВА
TOWEL RADIATOR FOR BATHROOM STRAIGHT**



Арт. № Item N	Баркод Barcode		L- Габарит на лирата/ Width/mm	H-Височина на лирата/ Height/mm	N-Междусие на лирата/ Centre distance/ mm	Водно съдържание/ Water content/Lt.	Watt/ ΔT50°	Watt/ ΔT60°	Брой тръбички/ Qty of pipes Ø 22
2725	3800154012044		400	600	355	2,33	248	305	12
2780	3800154012051		400	800	355	2,91	304	374	14
27100	3800154012068		400	900	355	3,35	334	411	15
2741	3800154028892		400	1000	355	3,48	360	443	16
2781	3800154012075		400	1200	355	4,26	442	544	20
2782	3800154012082		400	1400	355	4,83	498	613	22
2783	3800154012099		400	1600	355	5,40	554	682	24
2739	3800154028908		500	800	455	3,36	361	444	14
27109	3800154028915		500	1200	455	4,90	524	645	20
27110	3800154032165		500	1400	455	5,54	589	725	22
27111	3800154032172		500	1600	455	6,17	653	804	24
27112	3800154032189		600	1200	555	5,54	607	747	20
27113	3800154032196		600	1400	555	6,24	679	836	22
27114	3800154032202		600	1600	555	6,94	752	926	24

ОТОПЛЕНИЕ HEATING

СТОМАНЕНА ЛИРА ПРАВА ХРОМ TOWEL RADIATOR FOR BATHROOM STRAIGHT CHROME



Арт. № Item N	Баркод Barcode		L- Габарит на лирата/Width/mm	H-Височина на лирата/Height/ mm	N-Междусие на лирата/Centre distance/mm	Водно съдържание/ Water content/Lt.	Watt/ ΔT50°	Watt/ ΔT60°	Брой тръбички/Qty of pipes Ø22
273001	3800154028946		400	600	355	2,33	163	201	12
273002	3800154028953		400	800	355	2,91	201	247	14
273003	3800154023651		400	1200	355	4,26	292	359	16
273004	3800154028960		400	1400	355	4,83	329	405	20
273005	3800154032134		400	1600	355	5,40	366	450	24
273006	3800154028977		500	800	455	3,36	239	294	14
273008	3800154028984		500	1200	455	4,90	346	426	20
273009	3800154028991		500	1400	455	5,54	389	479	22
273010	3800154032141		500	1600	455	6,17	431	530	24
273011	3800154030437		600	800	555	3,80	277	341	14
273013	3800154030444		600	1200	455	5,54	401	494	16
273014	3800154030451		600	1400	555	6,24	449	553	20
273015	3800154032158		600	1600	555	6,94	496	610	24

СТОМАНЕНА ЛИРА ПРАВА ЧЕРНА TOWEL RADIATOR FOR BATHROOM STRAIGHT BLACK SILKY



Арт. № Item N	Баркод Barcode		L- Габарит на лирата/Width/mm	H-Височина на лирата/Height/ mm	N-Междусие на лирата/Centre distance/mm	Водно съдържание/ Water content/Lt.	Watt/ ΔT50°	Watt/ ΔT60°	Брой тръбички/Qty of pipes Ø22
100073	3800154040856		400	1200	355	4,26	292	359	16
100074	3800154040863		500	1200	455	4,90	346	426	20



THS[®]
THERMOSTYLE



ЕЛЕКТРИЧЕСКИ НАГРЕВАТЕЛИ ELECTRIC HEATERS

THS[®]

THERMOSTYLE

ПРЕДНАЗНАЧЕНИЕ

Нагревателят THS е потопяем неподвижен нагревател с електронен термостат, който може да се използва в централна система за отопление (може да се монтира във всички видове радиатори като чугунени, стоманени и алуминиеви) или за отопление на малки системи като например лири за баня. Той е особено ефективен като алтернатива за отопление в периодите преди и след отоплителния сезон, но дори и в самия отоплителен сезон се използва, за да компенсира лошото функциониране или повредите на съществуващите системи за централно отопление. Нагревателят THS дава възможност да се отоплява само едно помещение. Устройството не е предвидено да се монтира на резервоари за вода.

PURPOSE

It is installed into the heating bodies with a heating power that to be minimum 20% higher comparing to the power of THS heater to be installed (heating power of radiators is given according the EN 442, for conditions 90/70/20° C).

It is particularly effective as an alternative battery in the periods prior to and after the heating season, but even in the very heating season it is used to compensate poor operation of the existing central heating systems. It enables rationalized heating (as required, only one room can be heated.). The unit is not provided for installation in water tanks.



ЕЛЕКТРИЧЕСКИ НАГРЕВАТЕЛИ С ТЕРМОСТАТ ELECTRIC HEATERS WITH THERMOSTAT

ЕЛЕКТРИЧЕСКИ НАГРЕВАТЕЛ С ТЕРМОСТАТ БЯЛА ГЛАВА ELECTRIC HEATER WITH THERMOSTAT WHITE HEAD

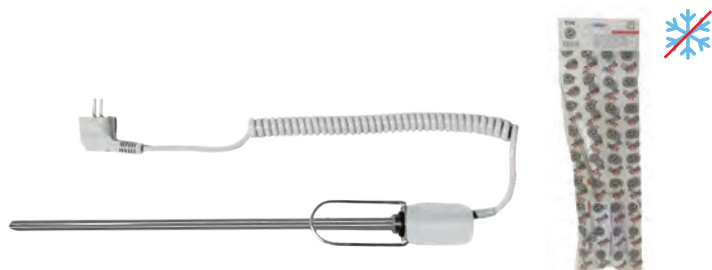

Тип Type	Арт. № Item №	Баркод Barcode	Thermal power (Watt)	Дължина на нагревателя/ Length of body (cm)	
THS03W	99081	3800154018497	300	20	✓
THS06W	99093	3800154018480	600	30	✓
THS09W	9906	3800154018442	900	40	✓
THS12W	9915	3800154018473	1200	45,5	✓
THS15W	9908	3800154018459	1500	48	✓
THS20W	9907	3800154018466	2000	63	✓

ЕЛЕКТРИЧЕСКИ НАГРЕВАТЕЛ С ТЕРМОСТАТ ХРОМ ГЛАВА ELECTRIC HEATER WITH THERMOSTAT CHROME PLATED HEAD



Тип Type	Арт. № Item №	Баркод Barcode	Thermal power (Watt)	Дължина на нагревателя/ Length of body (cm)	
THS03CH	99091	3800154018428	300	20	✓
THS06CH	99092	3800154018435	600	30	✓
THS09CH	7634	3800154030321	900	40	✓
THS12CH	7635	3800154030338	1200	45,5	✓
THS15CH	7636	3800154030345	1500	48	✓
THS20CH	7637	3800154030352	2000	63	✓

THS[®]

THERMOSTYLE



ОТОПЛЕНИЕ HEATING

ЕЛЕКТРИЧЕСКИ НАГРЕВАТЕЛ С ТЕРМОСТАТ ЧЕРНА ГЛАВА ELECTRIC HEATER WITH THERMOSTAT BLACK HEAD



Тип Type	Арт. № Item №	Баркод Barcode	Thermal power (Watt)	Дължина на нагревателя/ Length of body (cm)	
THS03BL	7639	3800154030369	300	30	✓
THS06BL	7640	3800154030376	600	35	✓
THS09BL	7641	3800154030383	900	40.5	✓
THS12BL	7642	3800154030390	1200	45	✓
THS15BL	7643	3800154030406	1500	48	✓
THS20BL	7644	3800154030413	2000	60.5	✓



ФУНКЦИЯ ПРОТИВ ЗАМРЪЗВАНЕ ANTI FROST PROTECTION

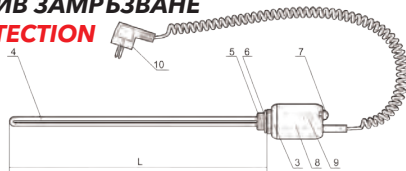

ТЕХНИЧЕСКО ОПИСАНИЕ/ TECHNICAL DESCRIPTION

Експлоатацията на нагревател тип THS се основава на „термосифонен ефект“. Когато устройството тип THS е вградено в отоплителен уред, то трябва да е свързано с напрежение в обхвата от 220 до 240 V с честота от 50 или 60 Hz. Свързването на устройството е възможно посредством щепсела, който се включва в контакт. Инсталирани са регулируеми ръчно термостати в устройството THS, в обхвата от 65-75 °C.

Installation of the THS heater enables the heating battery (radiator, towel warmer) to function as a unique system which individual parts (radiator ribs, elements) are quite uniformly "heated through" owing to the circulation of water ("thermosiphon effect"). Installed THS type heater is connected to the electric power supply in a range from 220-240V with the frequency of 50 or 60 Hz. Temperature control done linearly from 5 to 60°C, and as a protection from possible overheating due to the electric malfunction or irregular a current - responsive elements (thermal fuse).

ТЕХНИЧЕСКИ ХАРАКТЕРИСТИКИ/ TECHNICAL DATA

Модел Model	THS03	THS06	THS09	THS12	THS15	THS20
Електрозахранване Electric power supply	220 + 240 V; 50/60 Hz					
Мощност Heater power /W/	300 L-30 cm	600 L-35cm	900 L-40.5 cm	1200 L-45 cm	1500 L-48cm	2000 L-60.5cm
Температурен контрол Temperature control	5+40 ± 3°C					
Електрически кабел 1.5 m Connecting cable 1.5 m	ART 105 H05VV-F 3x0.75					
Температура на топене Melting temperature of the current-responsive element	94°C					
Присъединителна резба Mechanical connection	G ½"					
IP	44					
Изолационен клас Insulation class	I					

ЕЛЕКТРИЧЕСКИ НАГРЕВАТЕЛИ С ФИКСИРАН ТЕРМОСТАТ ELECTRIC HEATER WITH FIXED THERMOSTAT

ЕЛЕКТРИЧЕСКИ НАГРЕВАТЕЛ С ФИКСИРАН ТЕРМОСТАТ БЯЛ ELECTRIC HEATER FIXED THERMOSTAT WHITE



Тип Type	Арт. № Item №	Баркод Barcode	Thermal power (Watt)	Дължина на нагревателя/ Length of body (cm)	
THS03F	99094	3800154019272	300	30	✓
THS06F	99095	3800154019289	600	35	✓

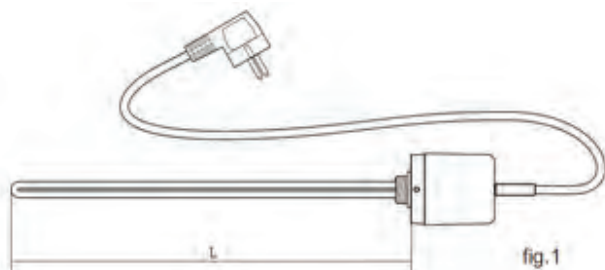

ТЕХНИЧЕСКО ОПИСАНИЕ/ TECHNICAL DESCRIPTION

Експлоатацията на нагревател тип THS F се основава на „термосифонен ефект“. Когато устройството тип THS F е вградено в отоплителен уред, то трябва да е свързано с напрежение в обхвата от 220 до 240 V с честота от 50 или 60 Hz. Свързването на устройството е възможно посредством щепсел. Температурния контрол на нагревателното тяло се извършва посредством вграден фиксиран термостат в THS F, в диапазон от 65 до 75 °C.

В случай на нарушено функциониране на опериращия термостат, като защитно устройство е вграден защитен термостат, реагиращ на температура от 90 °C.

Installation of the THS F heater enables the heating battery to function as unique system which individual parts are quite uniformly "heated through" owing to the circulation of water ("thermosiphon effect"). Installed THS F heater is connected to the electric power supply in a range from 220-240V with frequency of 50 or 60 Hz. Device connection is possible either using the switch plug or plug-in thermostat. Temperature control of the heating body is done using the thermostats incorporated in the THS F device in the range from 65 до 75 °C. In case of malfunction there is incorporated protective thermostat, reacting on temperature of 90°C.

ТЕХНИЧЕСКИ ХАРАКТЕРИСТИКИ/ TECHNICAL DATA

Модел Model	THS03F	THS06F
Електрозахранване Electric power supply	220 + 240 V; 50/60 Hz	
Мощност Heater power /W/	300 L-30 cm	600 L-35cm
Температурен контрол Temperature control	5+40 ± 3°C	
Електрически кабел 1.5 m Connecting cable 1.5 m	H05VV-F 3x0.75	
IP	44	
Изолационен клас Insulation class	I	
Тегло Mass/Weight (g) ±5	455	460





ОТОПЛЕНИЕ HEATING

ПЛАСТИФИЦИРАНА КОНЗОЛА С ДЮБЕЛ КОМПЛЕКТ 2 БРОЯ HANGERS WITH PLASTIC COVER 2 PCS



Размер Dimension	Арт. № Item №	Баркод Barcode			
9 * 170	89932	3800154033148	2/100		✓
9 * 195	89942	3800154033155	2/100		✓

КОНЗОЛА С ДЮБЕЛ ПРАХОВО БОЯДИСАНА КОМПЛЕКТ 2 БРОЯ HANGERS FOR ALUMINIUM RADIATOR 2 PCS



Размер Dimension	Арт. № Item №	Баркод Barcode			
170 mm	26642	3800154009372	2/500		✓
195 mm	26722	3800154009389	2/200		✓
230 mm	26602	3800154015533	2/400		✓

КОНЗОЛА ЗА АЛУМИНИЕВ РАДИАТОР ЪГЛОВА - ДВОЙНО ФИКСИРАЩА ANGEL HANGER FOR ALUMINIUM RADIATOR



Размер Dimension	Арт. № Item №	Баркод Barcode			
	2663	3800154009396	1/300		✗

КИТ КОМПЛЕКТ РАДИАТОРЕН - 7 ЧАСТИ SET 7 IN 1 FOR ALUMINIUM RADIATOR



Размер Dimension	Арт. № Item №	Баркод Barcode			
1 * 1/2"	2440	3800154009426	1/40		✓

КИТ КОМПЛЕКТ РАДИАТОРЕН С 2 БРОЯ КОНЗОЛИ - 11 ЧАСТИ SET 11 IN 1 FOR ALUMINIUM RADIATOR 2 HANGERS INCLUDED



Размер Dimension	Арт. № Item №	Баркод Barcode			
170 mm 1 * 1/2"	2017	3800154009433	1/40		✓

КИТ КОМПЛЕКТ РАДИАТОРЕН С 3 БРОЯ КОНЗОЛИ - 13 ЧАСТИ SET 13 IN 1 FOR ALUMINIUM RADIATOR 3 HANGERS INCLUDED



Размер Dimension	Арт. № Item №	Баркод Barcode			
170 mm 1 * 1/2"	8290	3800154031588	1/40		✓



**СТОЙКА ЗА АЛУМИНИЕВ РАДИАТОР
FLOOR HANGER FOR ALUMINIUM RADIATOR**



Размер Dimension	Арт. № Item №	Баркод Barcode			
H 290 mm	2662	3800154009402	1/50	<input checked="" type="checkbox"/>	<input checked="" type="checkbox"/>
H 390 mm	2656	3800154026225	1/50	<input checked="" type="checkbox"/>	<input checked="" type="checkbox"/>

**СТОЙКА ЗА ПАНЕЛЕН РАДИАТОР
FLOOR HANGER FOR PANEL RADIATOR**



Размер Dimension	Арт. № Item №	Баркод Barcode			
H 300 mm	2655	3800154009419	1/50	<input checked="" type="checkbox"/>	<input checked="" type="checkbox"/>

**ЛИРА ОКОМПЛЕКТОВКА 3 БРОЯ КОНЗОЛИ КОМПЛЕКТ С
КРЕПЕЖНИ ЕЛЕМЕНТИ
HANGER FOR TOWEL - 3 PCS IN A SET**



Размер Dimension	Арт. № Item №	Баркод Barcode			
	2738	3800154026942	1/50	<input checked="" type="checkbox"/>	<input checked="" type="checkbox"/>

**НИПЕЛ ЗА АЛУМИНИЕВ РАДИАТОР
NIPPEL CONNECTOR FOR ALUMINIUM RADIATOR**



Размер Dimension	Арт. № Item №	Баркод Barcode			
1"	2442	3800154009365	10/500	<input checked="" type="checkbox"/>	<input checked="" type="checkbox"/>

**РЕДУКЦИЯ ЗА АЛУМИНИЕВ РАДИАТОР С УПЛЪТНИТЕЛ
END REDUCER FOR ALUMINIUM RADIATOR**



Размер Dimension	Арт. № Item №	Баркод Barcode			
1**1/2" ДЯСНА/ RIGHT	2437	3800154009464	10/200	<input checked="" type="checkbox"/>	<input checked="" type="checkbox"/>
1**1/2" ЛЯВА/ LEFT	2438	3800154009471	10/200	<input checked="" type="checkbox"/>	<input checked="" type="checkbox"/>

**ТАПА ЗА АЛУМИНИЕВ РАДИАТОР С УПЛЪТНИТЕЛ
END CAP FOR ALUMINIUM RADIATOR**



Размер Dimension	Арт. № Item №	Баркод Barcode			
1" ДЯСНА/RIGHT	2435	3800154009440	10/200	<input checked="" type="checkbox"/>	<input checked="" type="checkbox"/>
1" ЛЯВА/LEFT	2436	3800154009457	10/200	<input checked="" type="checkbox"/>	<input checked="" type="checkbox"/>

ОТОПЛЕНИЕ HEATING

РЪЧЕН ОБЕЗВЪЗДУШИТЕЛ MANUAL AIR VENT



2416



9894

Размер Dimension	Арт. № Item №	Баркод Barcode			
1/2"	2416	3800154009303	10/1000	<input checked="" type="checkbox"/>	<input checked="" type="checkbox"/>
1/2" хром	9894	3800154040320	100/1000	<input checked="" type="checkbox"/>	<input checked="" type="checkbox"/>

МЕТАЛНО КЛЮЧЕ ЗА РЪЧЕН ОБЕЗВЪЗДУШИТЕЛ METAL KEY FOR MANUAL AIR VENT



Размер Dimension	Арт. № Item №	Баркод Barcode			
5 mm * 5 mm	24162	3800154016998	1/3000	<input checked="" type="checkbox"/>	<input checked="" type="checkbox"/>
5 mm * 5 mm	2416200	3800154040313	100/3000	<input checked="" type="checkbox"/>	<input checked="" type="checkbox"/>

АВТОМАТИЧЕН ОБЕЗВЪЗДУШИТЕЛ ПРАВ МЕСИНГ НИКЕЛ ECONOMIC AUTOMATIC AIR VENT STRAIGHT BRASS NICKEL PLATED ECONOMIC



Размер Dimension	Арт. № Item №	Баркод Barcode			
1/2"	2400	3800154022357	1/100	<input checked="" type="checkbox"/>	<input checked="" type="checkbox"/>

АВТОМАТИЧЕН ОБЕЗВЪЗДУШИТЕЛ ЪГЛОВ МЕСИНГ НИКЕЛ ECONOMIC AUTOMATIC AIR VENT ANGLE BRASS NICKEL PLATED ECONOMIC



Размер Dimension	Арт. № Item №	Баркод Barcode			
1/2"	2401	3800154022364	1/100	<input checked="" type="checkbox"/>	<input checked="" type="checkbox"/>

АВТОМАТИЧЕН ОБЕЗВЪЗДУШИТЕЛ ПРАВ МЕСИНГ НИКЕЛ AUTOMATIC AIR VENT STRAIGHT BRASS NICKEL PLATED



Размер Dimension	Арт. № Item №	Баркод Barcode			
1/2"	2417	3800154009310	1/100	<input checked="" type="checkbox"/>	<input checked="" type="checkbox"/>

АВТОМАТИЧЕН ОБЕЗВЪЗДУШИТЕЛ ЪГЛОВ МЕСИНГ НИКЕЛ AUTOMATIC AIR VENT ANGLE BRASS NICKEL PLATED



Размер Dimension	Арт. № Item №	Баркод Barcode			
1/2"	2421	3800154009327	1/100	<input checked="" type="checkbox"/>	<input checked="" type="checkbox"/>

АВТОМАТИЧЕН ОБЕЗВЪЗДУШИТЕЛ ПРАВ МЕСИНГ
AUTOMATIC AIR VENT STRAIGHT BRASS



Размер Dimension	Арт. № Item №	Баркод Barcode		
1/2"	6762	3800154028236	1/100	

АВТОМАТИЧЕН ОБЕЗВЪЗДУШИТЕЛ ПРАВ МЕСИНГ ХРОМ С КЛАПА
AUTOMATIC AIR VENT STRAIGHT WITH CHECK VALVE BRASS CHROME PLATED



Размер Dimension	Арт. № Item №	Баркод Barcode		
1/2"	5911	3800154022296	1/100	

АВТОМАТИЧЕН ОБЕЗВЪЗДУШИТЕЛ МЕСИНГ НИКЕЛ
AUTOMATIC AIR VENT STRAIGHT BRASS NICKEL PLATED



Размер Dimension	Арт. № Item №	Баркод Barcode		
1" ЛЯВ/ LEFT	2418	3800154009334	1/100	
1" ДЕСЕН/RIGHT	2420	3800154009341	1/100	

АВТОМАТИЧЕН ОБЕЗВЪЗДУШИТЕЛ МЕСИНГ НИКЕЛ SOLAR
AUTOMATIC AIR VENT STRAIGHT BRASS NICKEL PLATED SOLAR



Размер Dimension	Арт. № Item №	Баркод Barcode		
1/2"	24244	3800154023217	1/100	

АВТОМАТИЧЕН ОБЕЗВЪЗДУШИТЕЛ ПРАВ BLACK
AUTOMATIC AIR VENT STRAIGHT BLACK



Размер Dimension	Арт. № Item №	Баркод Barcode		
1/2"	7751	3800154031427	1/100	

АВТОМАТИЧЕН ОБЕЗВЪЗДУШИТЕЛ ПРАВ С КЛАПА МЕСИНГ
BRASS AUTOMATIC AIR VENT STRAIGHT WHIT CHECK VALVE



Размер Dimension	Арт. № Item №	Баркод Barcode		
1/2"	7752	3800154031434	1/100	

ОТОПЛЕНИЕ HEATING

АВТОМАТИЧЕН ОБЕЗВЪЗДУШИТЕЛЕН КЛАПАН 1/2" AIRVENT 1/2"



8301

Размер Dimension	Арт. № Item №	Баркод Barcode			
1/2"	8301	3800154031779	1/100		
1/2"	8300	3800154031779	10/1000		

КЛАПА ЗА АВТОМАТИЧЕН ОБЕЗВЪЗДУШИТЕЛ МЕСИНГ ХРОМ BRASS CHROME PATED CHECK VALVE FOR AIRVENT



Размер Dimension	Арт. № Item №	Баркод Barcode			
1/2"	24192				

РАДИАТОРЕН СЕТ ЪГЛОВ 3 В 1 RADIATOR VALVE SET - ANGLE 3 in 1

ЪГЛОВ
ANGLE



Размер Dimension	Арт. № Item №	Баркод Barcode			
1/2"	6183	3800154023590	1/40		



Комплектът включва:

- Ъглов радиаторен кран за термоглава 1/2";
- Ъглов секретен радиаторен кран 1/2";
- Термоглава - M30 X 1.5;

The set includes:

- Angle radiator valve for thermostatic head 1/2";
- Angle safety radiator valve 1/2";
- Thermostatic head - M30 X 1.5;

РАДИАТОРЕН СЕТ ПРАВ 3 В 1 RADIATOR VALVE SET - STRAIGHT 3 in 1

ПРАВ
STRAIGHT



Размер Dimension	Арт. № Item №	Баркод Barcode			
1/2"	6891	3800154029066	1/40		



Комплектът включва:

- Прав радиаторен кран за термоглава 1/2";
- Прав секретен радиаторен кран 1/2";
- Термоглава - M30 X 1.5;

The set includes:

- Straight radiator valve for thermostatic head 1/2";
- Straight safety radiator valve 1/2";
- Thermostatic head - M30 X 1.5;



**ОТОПЛЕНИЕ
HEATING**

**РАДИАТОРЕН СЕТ LUX DUO BLACK ПРАВ
RADIATOR SET LUX DUO BLACK STRAIGHT**



Размер Dimension	Арт. № Item №	Баркод Barcode			
1/2"	7603	3800154030062	1/20		

**РАДИАТОРЕН СЕТ LUX DUO BLACK ЪГЛОВ
RADIATOR SET LUX DUO BLACK ANGLE**



Размер Dimension	Арт. № Item №	Баркод Barcode			
1/2"	7600	3800154030031	1/20		

**РАДИАТОРЕН СЕТ LUX DUO WHITE ПРАВ
RADIATOR SET LUX DUO WHITE STRAIGHT**



Размер Dimension	Арт. № Item №	Баркод Barcode			
1/2"	7604	3800154030079	1/20		

**РАДИАТОРЕН СЕТ LUX DUO WHITE ЪГЛОВ
RADIATOR SET LUX DUO WHITE ANGLE**



Размер Dimension	Арт. № Item №	Баркод Barcode			
1/2"	7601	3800154030048	1/20		

**РАДИАТОРЕН СЕТ LUX DUO CHROME ПРАВ
RADIATOR SET LUX DUO CHROME STRAIGHT**



Размер Dimension	Арт. № Item №	Баркод Barcode			
1/2"	7605	3800154030086	1/20		

**РАДИАТОРЕН СЕТ LUX DUO CHROME ЪГЛОВ
RADIATOR SET LUX DUO CHROME ANGLE**



Размер Dimension	Арт. № Item №	Баркод Barcode			
1/2"	7602	3800154030055	1/20		

РАДИАТОРЕН СЕТ LUX DUO BLACK ПРАВ
RADIATOR SET LUX DUO BLACK STRAIGHT



Размер Dimension	Арт. № Item №	Баркод Barcode			
1/2" x 16 mm	7609	3800154030123	1/20		✓

РАДИАТОРЕН СЕТ LUX DUO BLACK ЪГЛОВ
RADIATOR SET LUX DUO BLACK ANGLE



Размер Dimension	Арт. № Item №	Баркод Barcode			
1/2" x 16 mm	7606	3800154030093	1/20		✓

РАДИАТОРЕН СЕТ LUX DUO WHITE ПРАВ
RADIATOR SET LUX DUO WHITE STRAIGHT

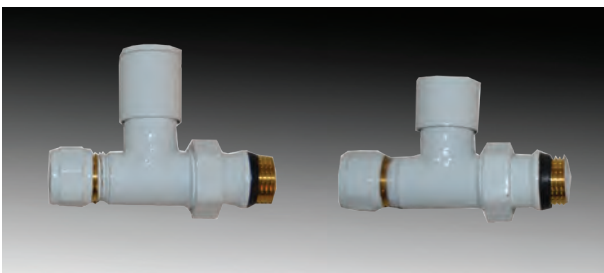

Размер Dimension	Арт. № Item №	Баркод Barcode			
1/2" x 16 mm	7610	3800154030130	1/20		✓

РАДИАТОРЕН СЕТ LUX DUO WHITE ЪГЛОВ
RADIATOR SET LUX DUO WHITE ANGLE



Размер Dimension	Арт. № Item №	Баркод Barcode			
1/2" x 16 mm	7607	3800154030109	1/20		✓

РАДИАТОРЕН СЕТ LUX DUO CHROME ПРАВ
RADIATOR SET LUX DUO CHROME STRAIGHT



Размер Dimension	Арт. № Item №	Баркод Barcode			
1/2" x 16 mm	7611	3800154030147	1/20		✓

РАДИАТОРЕН СЕТ LUX DUO CHROME ЪГЛОВ
RADIATOR SET LUX DUO CHROME ANGLE



Размер Dimension	Арт. № Item №	Баркод Barcode			
1/2" x 16 mm	7608	3800154030116	1/20		✓

ОТОПЛЕНИЕ HEATING

РАДИАТОРЕН СЕТ CAYMAN 3 В 1 BLACK ПРАВ RADIATOR SET CAYMAN 3 IN 1 BLACK STRAIGHT



Размер Dimension	Арт. № Item №	Баркод Barcode		
1/2"	7577	3800154029806	1/20	✓

РАДИАТОРЕН СЕТ CAYMAN 3 В 1 BLACK ЪГЛОВ RADIATOR SET CAYMAN 3 IN 1 BLACK ANGLE



Размер Dimension	Арт. № Item №	Баркод Barcode		
1/2"	7576	3800154029790	1/20	✓

РАДИАТОРЕН СЕТ CAYMAN 3 В 1 WHITE ПРАВ RADIATOR SET CAYMAN 3 IN 1 WHITE STRAIGHT



Размер Dimension	Арт. № Item №	Баркод Barcode		
1/2"	7579	3800154029868	1/20	✓

РАДИАТОРЕН СЕТ CAYMAN 3 В 1 WHITE ЪГЛОВ RADIATOR SET CAYMAN 3 IN 1 WHITE ANGLE



Размер Dimension	Арт. № Item №	Баркод Barcode		
1/2"	7578	3800154029851	1/20	✓

РАДИАТОРЕН СЕТ CAYMAN 3 В 1 CHROME ПРАВ RADIATOR SET CAYMAN 3 IN 1 CHROME STRAIGHT



Размер Dimension	Арт. № Item №	Баркод Barcode		
1/2"	7581	3800154029882	1/20	✓

РАДИАТОРЕН СЕТ CAYMAN 3 В 1 CHROME ЪГЛОВ RADIATOR SET CAYMAN 3 IN 1 CHROME ANGLE



Размер Dimension	Арт. № Item №	Баркод Barcode		
1/2"	7580	3800154029875	1/20	✓

Всеки комплект съдържа:

1. ТЕРМОГЛАВА M30 x 1.5
2. ПРАВ РАДИАТОРЕН ТЕРМО КРАН 1/2"
3. ПРАВ СЕКРЕТЕН РАДИАТОРЕН КРАН 1/2"
4. АДАПТОРИ С ГАЙКИ ЗА ТРЪБА PEX-AL-PEX Ø16MM - 2 БР.
5. ГАЙКИ С О-ПРЪСТЕНИ ЗА МЕДНА ТРЪБА Ø15MM - 2 БР.

Each set includes:

1. THERMOSTATIC HEAD M30 x 1.5
2. STRAIGHT THERMOSTATIC RADIATOR VALVE
3. STRAIGHT SAFETY RADIATOR VALVE
4. FITTINGS WITH NUTS FOR PEX-AL-PEX Ø16MM - 2 PCS
5. NUTS WITH RINGS FOR COPPER PIPE Ø15MM - 2 PCS

РАДИАТОРЕН СЕТ CAYMAN 7 В 1 BLACK ПРАВ RADIATOR SET CAYMAN 7 IN 1 BLACK STRAIGHT



Адаптори с гайки за тръба Pex-Al-Pex Ø16 mm - 2 бр.
Гайки с о-пръстени за медна тръба Ø15 mm - 2 бр.
ВКЛЮЧЕНИ В КОМПЛЕКТА

Fittings with nuts for Pex-Al-Pex Ø16mm - 2 pcs
Nuts with rings for copper pipe Ø15mm - 2 pcs
INCLUDED IN THE SET

BLISTER

Размер Dimension	Арт. № Item №	Баркод Barcode			
1/2" x 16mm + 1/2" x 15mm	7583	3800154029820	1/20		



РАДИАТОРЕН СЕТ CAYMAN 7 В 1 WHITE ПРАВ RADIATOR SET CAYMAN 7 IN 1 WHITE STRAIGHT



Адаптори с гайки за тръба Pex-Al-Pex Ø16 mm - 2 бр.
Гайки с о-пръстени за медна тръба Ø15 mm - 2 бр.
ВКЛЮЧЕНИ В КОМПЛЕКТА

Fittings with nuts for Pex-Al-Pex Ø16mm - 2 pcs
Nuts with rings for copper pipe Ø15mm - 2 pcs
INCLUDED IN THE SET

BLISTER

Размер Dimension	Арт. № Item №	Баркод Barcode			
1/2" x 16mm + 1/2" x 15mm	7585	3800154029905	1/20		



РАДИАТОРЕН СЕТ CAYMAN 7 В 1 CHROME ПРАВ RADIATOR SET CAYMAN 7 IN 1 CHROME STRAIGHT



Адаптори с гайки за тръба Pex-Al-Pex Ø16 mm - 2 бр.
Гайки с о-пръстени за медна тръба Ø15 mm - 2 бр.
ВКЛЮЧЕНИ В КОМПЛЕКТА

Fittings with nuts for Pex-Al-Pex Ø16mm - 2 pcs
Nuts with rings for copper pipe Ø15mm - 2 pcs
INCLUDED IN THE SET

BLISTER

Размер Dimension	Арт. № Item №	Баркод Barcode			
1/2" x 16mm + 1/2" x 15mm	7587	3800154029929	1/20		



ОТОПЛЕНИЕ HEATING

Всеки комплект съдържа:

1. ТЕРМОГЛАВА M30 x 1.5
2. ЪГЛОВ РАДИАТОРЕН ТЕРМО КРАН 1/2"
3. ЪГЛОВ СЕКРЕТЕН РАДИАТОРЕН КРАН 1/2"
4. АДАПТОРИ С ГАЙКИ ЗА ТРЪБА РЕХ-AL-РЕХ Ø16MM - 2 БР.
5. ГАЙКИ С О-ПРЪСТЕНИ ЗА МЕДНА ТРЪБА Ø15MM - 2 БР.

Each set includes:

1. THERMOSTATIC HEAD M30 x 1.5
2. ANGLE THERMOSTATIC RADIATOR VALVE
3. ANGLE SAFETY RADIATOR VALVE
4. FITTINGS WITH NUTS FOR PEX-AL-PEX Ø16MM - 2 PCS
5. NUTS WITH RINGS FOR COPPER PIPE Ø15MM - 2 PCS

РАДИАТОРЕН СЕТ SAYMAN 7 В 1 BLACK ЪГЛОВ RADIATOR SET SAYMAN 7 IN 1 BLACK ANGLE



Адаптори с гайки за тръба Pex-Al-Pex Ø16 mm - 2 бр.
Гайки с о-пръстени за медна тръба Ø15 mm - 2 бр.
ВКЛЮЧЕНИ В КОМПЛЕКТА

Fittings with nuts for Pex-Al-Pex Ø16mm - 2 pcs
Nuts with rings for copper pipe Ø15mm - 2 pcs
INCLUDED IN THE SET



Размер Dimension	Арт. № Item №	Баркод Barcode		
1/2" x 16mm + 1/2" x 15mm	7582	3800154029813	1/20	✓



ОПЦИЯ №1/OPTION №1

Адаптори с гайки за тръба Pex-Al-Pex Ø16 mm - 2 бр.
Fittings with nuts for Pex-Al-Pex Ø16mm - 2 pcs



ОПЦИЯ №2/ OPTION №2

Гайки с о-пръстени за медна тръба Ø15 mm - 2 бр.
Nuts with rings for copper pipe Ø15mm - 2 pcs

РАДИАТОРЕН СЕТ SAYMAN 7 В 1 WHITE ЪГЛОВ RADIATOR SET SAYMAN 7 IN 1 WHITE ANGLE



Адаптори с гайки за тръба Pex-Al-Pex Ø16 mm - 2 бр.
Гайки с о-пръстени за медна тръба Ø15 mm - 2 бр.
ВКЛЮЧЕНИ В КОМПЛЕКТА

Fittings with nuts for Pex-Al-Pex Ø16mm - 2 pcs
Nuts with rings for copper pipe Ø15mm - 2 pcs
INCLUDED IN THE SET



Размер Dimension	Арт. № Item №	Баркод Barcode		
1/2" x 16mm + 1/2" x 15mm	7584	3800154029899	1/20	✓



ОПЦИЯ №1/OPTION №1

Адаптори с гайки за тръба Pex-Al-Pex Ø16 mm - 2 бр.
Fittings with nuts for Pex-Al-Pex Ø16mm - 2 pcs



ОПЦИЯ №2/ OPTION №2

Гайки с о-пръстени за медна тръба Ø15 mm - 2 бр.
Nuts with rings for copper pipe Ø15mm - 2 pcs

РАДИАТОРЕН СЕТ SAYMAN 7 В 1 CHROME ЪГЛОВ RADIATOR SET SAYMAN 7 IN 1 CHROME ANGLE



Адаптори с гайки за тръба Pex-Al-Pex Ø16 mm - 2 бр.
Гайки с о-пръстени за медна тръба Ø15 mm - 2 бр.
ВКЛЮЧЕНИ В КОМПЛЕКТА

Fittings with nuts for Pex-Al-Pex Ø16mm - 2 pcs
Nuts with rings for copper pipe Ø15mm - 2 pcs
INCLUDED IN THE SET



Размер Dimension	Арт. № Item №	Баркод Barcode		
1/2" x 16mm + 1/2" x 15mm	7586	3800154029912	1/20	✓



ОПЦИЯ №1/OPTION №1

Адаптори с гайки за тръба Pex-Al-Pex Ø16 mm - 2 бр.
Fittings with nuts for Pex-Al-Pex Ø16mm - 2 pcs



ОПЦИЯ №2/ OPTION №2

Гайки с о-пръстени за медна тръба Ø15 mm - 2 бр.
Nuts with rings for copper pipe Ø15mm - 2 pcs

Всеки комплект съдържа:

1. ТЕРМОГЛАВА M30 x 1.5
2. ДВОЙНО ЪГЛОВ РАДИАТОРЕН ТЕРМО КРАН 1/2"
3. ДВОЙНО ЪГЛОВ СЕКРЕТЕН РАДИАТОРЕН КРАН 1/2"
4. АДАПТОРИ С ГАЙКИ ЗА ТРЪБА PEX-AL-PEX Ø16MM - 2 БР.
5. ГАЙКИ С О-ПРЪСТЕНИ ЗА МЕДНА ТРЪБА Ø15MM - 2 БР.

Each set includes:

1. THERMOSTATIC HEAD M30 x 1.5
2. DOUBLE ANGLE THERMOSTATIC RADIATOR VALVE
3. DOUBLE ANGLE SAFETY RADIATOR VALVE
4. FITTINGS WITH NUTS FOR PEX-AL-PEX Ø16MM - 2 PCS
5. NUTS WITH RINGS FOR COPPER PIPE Ø15MM - 2 PCS

ДВОЙНО ЪГЛОВ СЕТ ЗА ЛИРА CAYMAN BLACK DOUBLE ANGEL SET FOR TOWEL CAYMAN BLACK



Адаптори с гайки за тръба Pex-Al-Pex Ø16 mm - 2 бр.
Гайки с о-пръстени за медна тръба Ø15 mm - 2 бр.
ВКЛЮЧЕНИ В КОМПЛЕКТА

Fittings with nuts for Pex-Al-Pex Ø16mm - 2 pcs
Nuts with rings for copper pipe Ø15mm - 2 pcs
INCLUDED IN THE SET



ОПЦИЯ №1/OPTION №1

Адаптори с гайки за тръба Pex-Al-Pex Ø16 mm - 2 бр.
Fittings with nuts for Pex-Al-Pex Ø16mm - 2 pcs

ОПЦИЯ №2/OPTION №2

Гайки с о-пръстени за медна тръба Ø15 mm - 2 бр.
Nuts with rings for copper pipe Ø15mm - 2 pcs

Размер Dimension	Арт. № Item №	Баркод Barcode			
1/2" x 16mm + 1/2" x 15mm	7613	3800154030161	1/20		

ДВОЙНО ЪГЛОВ СЕТ ЗА ЛИРА CAYMAN WHITE DOUBLE ANGEL SET FOR TOWEL CAYMAN WHITE



Адаптори с гайки за тръба Pex-Al-Pex Ø16 mm - 2 бр.
Гайки с о-пръстени за медна тръба Ø15 mm - 2 бр.
ВКЛЮЧЕНИ В КОМПЛЕКТА

Fittings with nuts for Pex-Al-Pex Ø16mm - 2 pcs
Nuts with rings for copper pipe Ø15mm - 2 pcs
INCLUDED IN THE SET



ОПЦИЯ №1/OPTION №1

Адаптори с гайки за тръба Pex-Al-Pex Ø16 mm - 2 бр.
Fittings with nuts for Pex-Al-Pex Ø16mm - 2 pcs

ОПЦИЯ №2/OPTION №2

Гайки с о-пръстени за медна тръба Ø15 mm - 2 бр.
Nuts with rings for copper pipe Ø15mm - 2 pcs

Размер Dimension	Арт. № Item №	Баркод Barcode			
1/2" x 16mm + 1/2" x 15mm	7614	3800154030178	1/20		

ДВОЙНО ЪГЛОВ СЕТ ЗА ЛИРА CAYMAN CHROME DOUBLE ANGEL SET FOR TOWEL CAYMAN CHROME



Адаптори с гайки за тръба Pex-Al-Pex Ø16 mm - 2 бр.
Гайки с о-пръстени за медна тръба Ø15 mm - 2 бр.
ВКЛЮЧЕНИ В КОМПЛЕКТА

Fittings with nuts for Pex-Al-Pex Ø16mm - 2 pcs
Nuts with rings for copper pipe Ø15mm - 2 pcs
INCLUDED IN THE SET



ОПЦИЯ №1/OPTION №1

Адаптори с гайки за тръба Pex-Al-Pex Ø16 mm - 2 бр.
Fittings with nuts for Pex-Al-Pex Ø16mm - 2 pcs

ОПЦИЯ №2/OPTION №2

Гайки с о-пръстени за медна тръба Ø15 mm - 2 бр.
Nuts with rings for copper pipe Ø15mm - 2 pcs

Размер Dimension	Арт. № Item №	Баркод Barcode			
1/2" x 16mm + 1/2" x 15mm	7612	3800154030154	1/20		



ВЕНТИЛ РАДИАТОРЕН ПРАВ ЗА ТЕРМОГЛАВА МЕСИНГ НИКЕЛ
RADIATOR VALVE FOR THERMOSTATIC HEAD STRAIGHT BRASS NICKEL PLATED



Размер Dimension	Арт. № Item №	Баркод Barcode			
M30 x 1.5 1/2"	24009	3800154009709	1/100		



ВЕНТИЛ РАДИАТОРЕН ПРАВ ЗА ТЕРМОГЛАВА МЕСИНГ ХРОМ
RADIATOR VALVE FOR THERMOSTATIC HEAD STRAIGHT BRASS CHROME PLATED



Размер Dimension	Арт. № Item №	Баркод Barcode			
M30 x 1.5 1/2"	240091	3800154021145	1/100		

ВЕНТИЛ РАДИАТОРЕН ЪГЛОВ ЗА ТЕРМОГЛАВА МЕСИНГ НИКЕЛ
RADIATOR VALVE FOR THERMOSTATIC HEAD ANGLE BRASS NICKEL PLATED



Размер Dimension	Арт. № Item №	Баркод Barcode			
M30 x 1.5 1/2"	24008	3800154009716	1/100		

ВЕНТИЛ РАДИАТОРЕН ЪГЛОВ ЗА ТЕРМОГЛАВА МЕСИНГ ХРОМ
RADIATOR VALVE FOR THERMOSTATIC HEAD ANGLE BRASS CHROME PLATED



Размер Dimension	Арт. № Item №	Баркод Barcode			
M30 x 1.5 1/2"	240081	3800154021152	1/100		





ВЕНТИЛ РАДИАТОРЕН ЪГЛОВ ЗА ТЕРМОГЛАВА С АДАПТОР МЕСИНГ НИКЕЛ
RADIATOR VALVE FOR THERMOSTATIC HEAD ANGLE BRASS NICKEL PLATED



Размер Dimension	Арт. № Item №	Баркод Barcode			
M30 x 1.5 Ø 16 mm x 1/2"	24004	3800154009730	1/100		

ВЕНТИЛ РАДИАТОРЕН ЪГЛОВ ЗА ТЕРМОГЛАВА С АДАПТОР МЕСИНГ ХРОМ
RADIATOR VALVE FOR THERMOSTATIC HEAD ANGLE BRASS CHROME PLATED



Размер Dimension	Арт. № Item №	Баркод Barcode			
M30 x 1.5 Ø 16 mm * x 1/2"	240041	3800154021169	1/100		

ОТОПЛЕНИЕ HEATING

ВЕНТИЛ РАДИАТОРЕН ПРАВ ЗА ТЕРМОГЛАВА С АДАПТОР МЕСИНГ НИКЕЛ
RADIATOR VALVE FOR THERMOSTATIC HEAD STRAIGHT BRASS NICKEL PLATED



Размер Dimension	Арт. № Item №	Баркод Barcode			
M30 x 1.5 Ø 16 mm x 1/2"	24005	3800154009723			

**МЕСИНГОВ ЗАТВАРЯЩ МЕХАНИЗЪМ М30 x 1.5
ЗА ТЕРМОСТАТИЧЕН КРАН СЪС СТЕПЕНИ**
BRASS CARTAGE M30 x 1.5 FOR THERMOSTATIC VALVE WITH RATES



Размер Dimension	Арт. № Item №	Баркод Barcode			
M30 x 1.5	7588	3800154029837			

ВЕНТИЛ РАДИАТОРЕН ПРАВ ЗА ТЕРМОГЛАВА 24*19
BRASS RADIATOR VALVE STRAIGHT FOR THERMOSTATIC HEAD 24*19



Размер Dimension	Арт. № Item №	Баркод Barcode			
24 x 19 x 1/2"	6893	3800154029080			

ВЕНТИЛ РАДИАТОРЕН ЪГЛОВ ЗА ТЕРМОГЛАВА 24*19
BRASS RADIATOR VALVE ANGLE FOR THERMOSTATIC HEAD 24*19



Размер Dimension	Арт. № Item №	Баркод Barcode			
24 x 19 x 1/2"	6892	3800154029073			

ВЕНТИЛ РАДИАТОРЕН ПРАВ МЕСИНГ НИКЕЛ
RADIATOR VALVE STRAIGHT BRASS NICKEL PLATED



Размер Dimension	Арт. № Item №	Баркод Barcode			
1/2"	2483	3800154009815			



ВЕНТИЛ РАДИАТОРЕН ПРАВ С АДАПТОР МЕСИНГ НИКЕЛ
**RADIATOR VALVE STRAIGHT FOR PEX-AL-PEX
PIPE BRASS NICKEL PLATED**



Размер Dimension	Арт. № Item №	Баркод Barcode			
Ø 16 mm x 1/2"	2462	3800154009792			



ВЕНТИЛ РАДИАТОРЕН ПРАВ СЕКРЕТЕН МЕСИНГ НИКЕЛ
SAFETY RADIATOR VALVE STRAIGHT BRASS NICKEL PLATED



Размер Dimension	Арт. № Item №	Баркод Barcode			
1/2"	160	3800154009822	20/200		

ВЕНТИЛ РАДИАТОРЕН ПРАВ СЕКРЕТЕН С АДАПТОР МЕСИНГ НИКЕЛ
SAFETY RADIATOR VALVE STRAIGHT FOR PEX-AL-PEX PIPE BRASS NICKEL PLATED



Размер Dimension	Арт. № Item №	Баркод Barcode			
Ø 16 mm x 1/2"	2482	3800154009839	13 /130		





ВЕНТИЛ РАДИАТОРЕН ЪГЛОВ МЕСИНГ НИКЕЛ
RADIATOR VALVE ANGLE BRASS NICKEL PLATED



Размер Dimension	Арт. № Item №	Баркод Barcode			
1/2"	2481	3800154009846	10/100		





ВЕНТИЛ РАДИАТОРЕН ЪГЛОВ С АДАПТОР МЕСИНГ НИКЕЛ
RADIATOR ANGLE VALVE FOR PEX-AL-PEX PIPE BRASS NICKEL PLATED



Размер Dimension	Арт. № Item №	Баркод Barcode			
Ø 16 mm x 1/2"	2480	3800154009808	10/100		

ВЕНТИЛ РАДИАТОРЕН ЪГЛОВ СЕКРЕТЕН МЕСИНГ НИКЕЛ
SAFETY RADIATOR ANGLE VALVE BRASS NICKEL PLATED



Размер Dimension	Арт. № Item №	Баркод Barcode			
1/2"	2461	3800154009853	20/200		

ВЕНТИЛ РАДИАТОРЕН ЪГЛОВ СЕКРЕТЕН С АДАПТОР МЕСИНГ НИКЕЛ
SAFETY RADIATOR ANGLE VALVE FOR PEX-AL-PEX PIPE BRASS NICKEL PLATED



Размер Dimension	Арт. № Item №	Баркод Barcode			
Ø 16 mm x 1/2"	24810	3800154009860	15/150		

ОТОПЛЕНИЕ HEATING

ТЕРМОГЛАВА ЗА КРАН СЪС ЗАКЛЮЧВАНЕ С ТЕЧЕН АГЕНТ THERMOSTATIC HEAD WITH LOCKER



Размер Dimension	Арт. № Item №	Баркод Barcode		
M30 x 1.5	6184	3800154023576	1/100	✓

ТЕРМОГЛАВА ЗА КРАН СНЕЖНО БЯЛА С ТЕЧЕН АГЕНТ THERMOSTATIC HEAD SNOW WHITE



Размер Dimension	Арт. № Item №	Баркод Barcode		
M30 x 1.5	6185	3800154023583	1/100	✓

ТЕРМОГЛАВА ЗА КРАН С ТЕЧЕН АГЕНТ THERMOSTATIC HEAD FOR RADIATOR VALVE



Размер Dimension	Арт. № Item №	Баркод Barcode		
M30 x 1.5	24007	3800154009747	1/100	✓

ТЕРМОГЛАВА ЗА КРАН ХРОМ С ТЕЧЕН АГЕНТ THERMOSTATIC HEAD FOR RADIATOR VALVE CHROME PLATED



Размер Dimension	Арт. № Item №	Баркод Barcode		
M30 x 1.5	24006	3800154009754	1/100	✓

ТЕРМОГЛАВА ЗА КРАН БЯЛА С ТЕЧЕН АГЕНТ THERMOSTATIC RADIATOR HEAD



Размер Dimension	Арт. № Item №	Баркод Barcode		
M30 x 1.5	7567	3800154029714	1/100	✓

ТЕРМОГЛАВА САУМАН БЯЛА С ТЕЧЕН АГЕНТ THERMOSTATIC RADIATOR HEAD CAYMAN WHITE



Размер Dimension	Арт. № Item №	Баркод Barcode		
M30 x 1.5	7570	3800154029745	1/100	✓

**ТЕРМОГЛАВА САУМАН БЯЛА С ТЕЧЕН АГЕНТ
THERMOSTATIC RADIATOR HEAD CAYMAN WHITE**



Размер Dimension	Арт. № Item №	Баркод Barcode			
M30 x 1.5	7571	3800154029752	1/100		✓

**ТЕРМОГЛАВА САУМАН ЧЕРНА С ТЕЧЕН АГЕНТ
THERMOSTATIC RADIATOR HEAD CAYMAN BLACK**



Размер Dimension	Арт. № Item №	Баркод Barcode			
M30 x 1.5	7572	3800154029769	1/100		✓

**ТЕРМОГЛАВА КАПИЛЯРНА БЯЛА С ТЕЧЕН АГЕНТ 20° - 60°
THERMOSTATIC RADIATOR HEAD 20° - 60°**



Размер Dimension	Арт. № Item №	Баркод Barcode			
M30 x 1.5	7573	3800154029776	1/50		✓

**ТЕРМОГЛАВА КАПИЛЯРНА БЯЛА С ТЕЧЕН АГЕНТ 30° - 70°
THERMOSTATIC RADIATOR HEAD 30° - 70°**



Размер Dimension	Арт. № Item №	Баркод Barcode			
M30 x 1.5	7574	3800154029783	1/50		✓

**ТЕРМОГЛАВА МИНИ БЯЛА С ТЕЧЕН АГЕНТ
THERMOSTATIC RADIATOR HEAD MINI WHITE**



Размер Dimension	Арт. № Item №	Баркод Barcode			
M30 x 1.5	7568	3800154029721	1/100		✓

**ТЕРМОГЛАВА МИНИ БЯЛА С ТЕЧЕН АГЕНТ
THERMOSTATIC RADIATOR HEAD MINI WHITE**



Размер Dimension	Арт. № Item №	Баркод Barcode			
M30 x 1.5	7569	3800154029738	1/100		✓

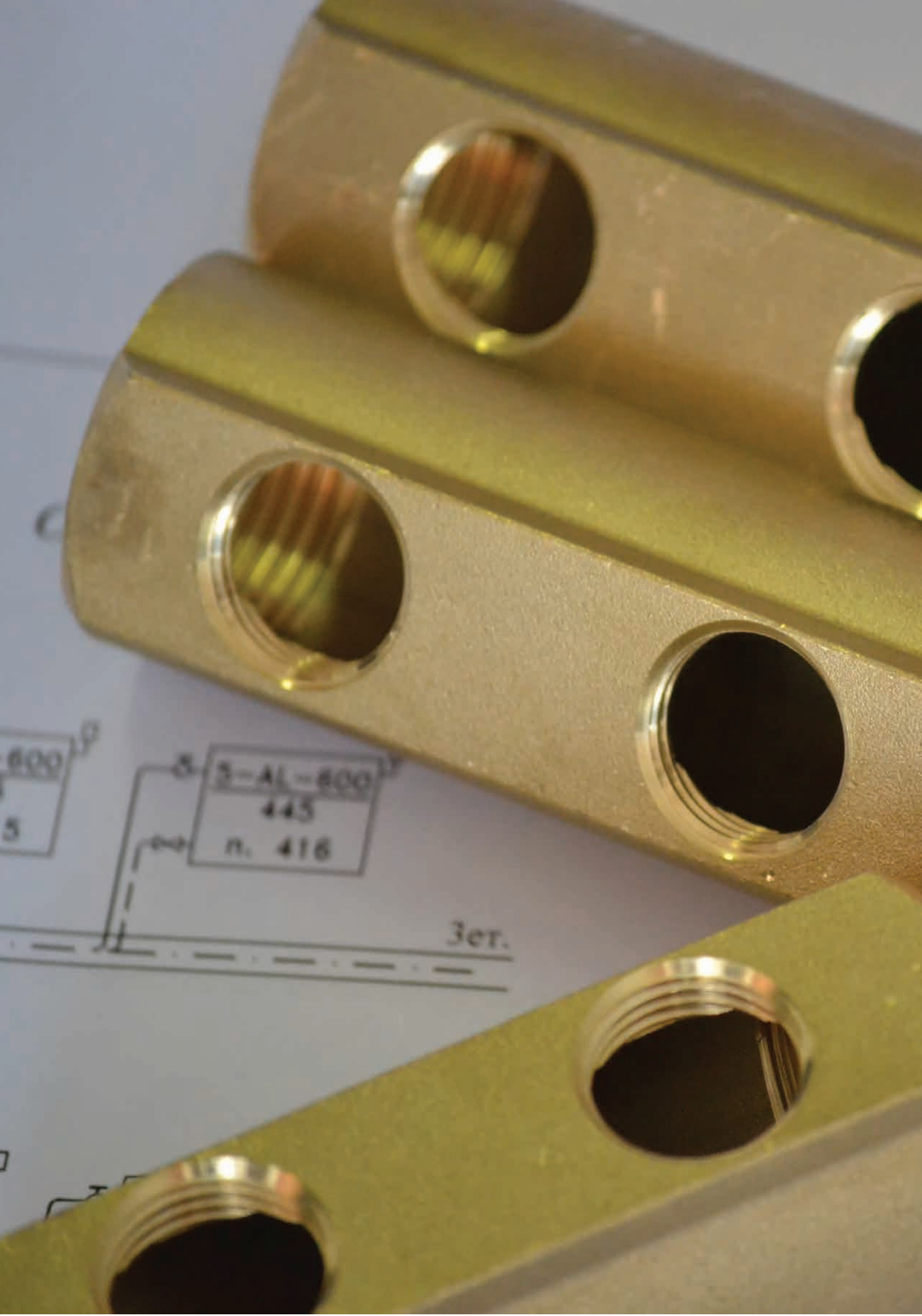

800
5

3-AL-800
445
n. 416

3er.

ПРОФИЛЕН КОЛЕКТОР 3/4" ЖЖ
BRASS FEMALE MANIFOLD 3/4" FF

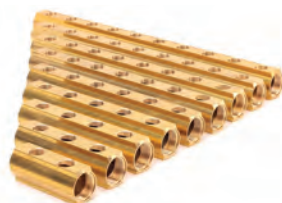

ПРОФИЛЕН КОЛЕКТОР 1" ЖЖ
BRASS FEMALE MANIFOLD 1" FF

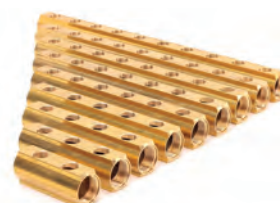

Размер Dimension	Арт. № Item №	Баркод Barcode			
2 ОТВОРА/ 2 WAYS	250	3800154022142	5/50	X	
3 ОТВОРА/ 3 WAYS	2501	3800154022159	5/30	X	
4 ОТВОРА/ 4 WAYS	2502	3800154022166	5/30	X	
5 ОТВОРА/ 5 WAYS	2491	3800154022173	5/15	X	
6 ОТВОРА/ 6 WAYS	2492	3800154022180	5/20	X	
7 ОТВОРА/ 7 WAYS	2493	3800154025327	5/20	X	
8 ОТВОРА/ 8 WAYS	2494	3800154025334	5/20	X	
9 ОТВОРА/ 9 WAYS	2495	3800154025341	5/20	X	
10 ОТВОРА/ 10 WAYS	2496	3800154025310	5/20	X	

Размер Dimension	Арт. № Item №	Баркод Barcode			
2 ОТВОРА/ 2 WAYS	241	3800154009112	5/50	X	
3 ОТВОРА/ 3 WAYS	242	3800154009129	5/40	X	
4 ОТВОРА/ 4 WAYS	243	3800154009136	5/25	X	
5 ОТВОРА/ 5 WAYS	244	3800154009143	5/20	X	
6 ОТВОРА/ 6 WAYS	245	3800154009150	5/20	X	
7 ОТВОРА/ 7 WAYS	246	3800154009167	5/20	X	
8 ОТВОРА/ 8 WAYS	247	3800154009174	5/20	X	
9 ОТВОРА/ 9 WAYS	248	3800154009181	5/20	X	
10 ОТВОРА/ 10 WAYS	249	3800154009198	5/20	X	

ПРОФИЛЕН КОЛЕКТОР 1 1/4" ЖЖ
BRASS FEMALE MANIFOLD 1 1/4" FF

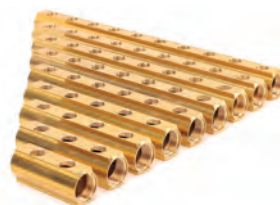

Размер Dimension	Арт. № Item №	Баркод Barcode			
2 ОТВОРА/ 2 WAYS	2414	3800154025150	10/30	X	
3 ОТВОРА/ 3 WAYS	2458	3800154022197	10/20	X	
4 ОТВОРА/ 4 WAYS	2459	3800154022203	10/15	X	
5 ОТВОРА/ 5 WAYS	2444	3800154025167	5/10	X	
6 ОТВОРА/ 6 WAYS	2445	3800154025174	5/10	X	
7 ОТВОРА/ 7 WAYS	24102	3800154025181	5/10	X	
8 ОТВОРА/ 8 WAYS	24103	3800154025198	5/10	X	
9 ОТВОРА/ 9 WAYS	24105	3800154025204	5/10	X	
10 ОТВОРА/ 10 WAYS	24106	3800154025211	5/10	X	

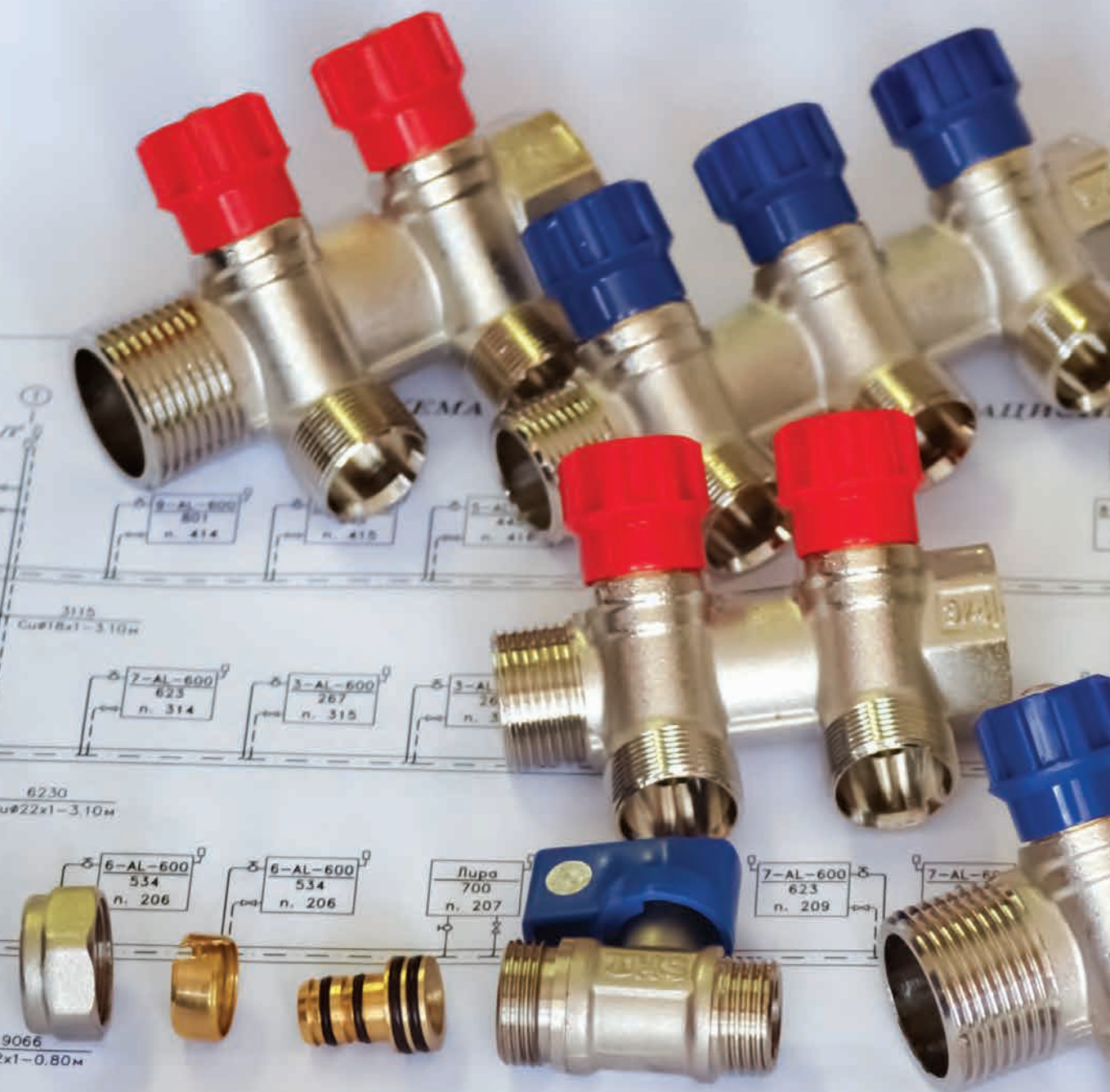
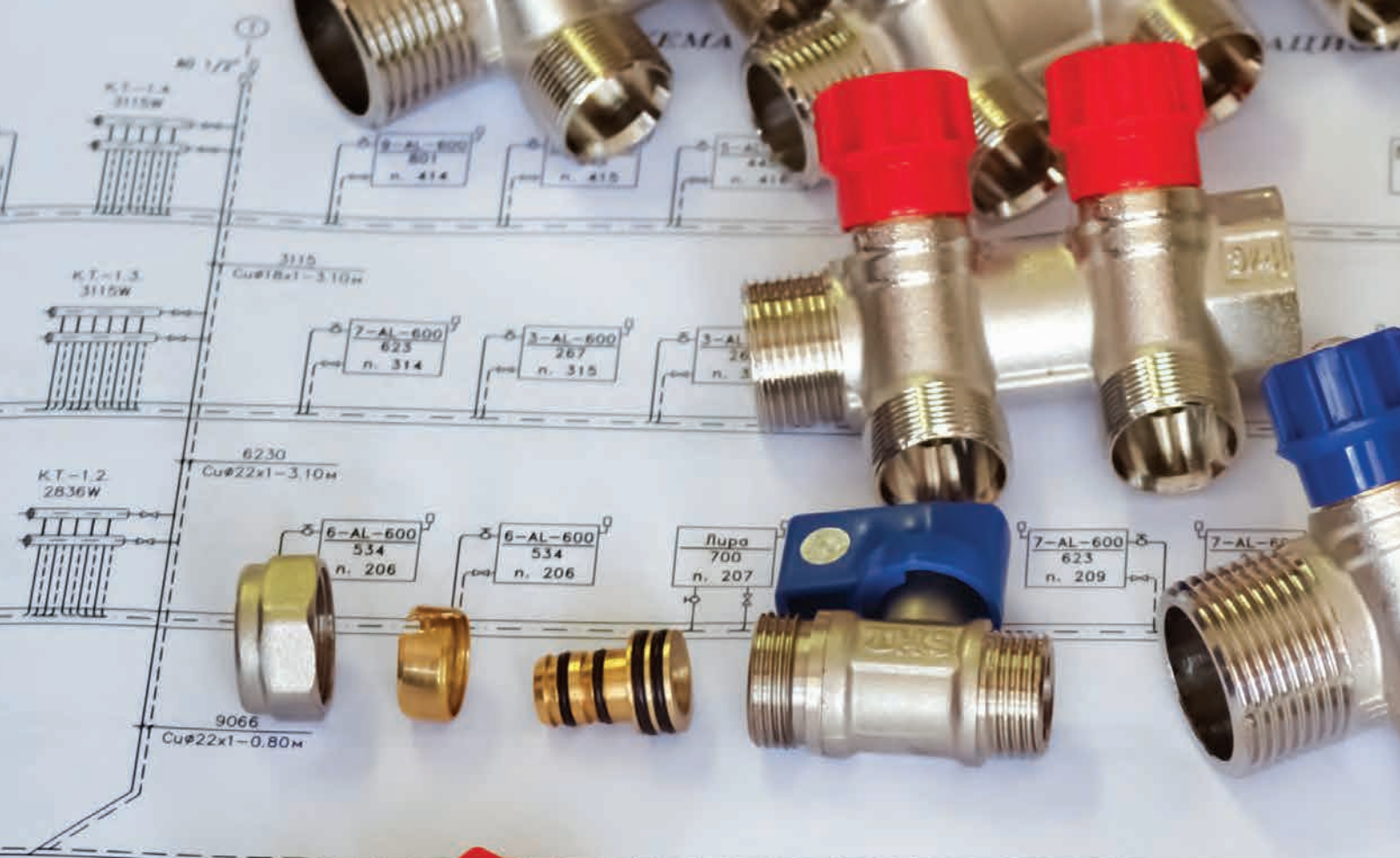
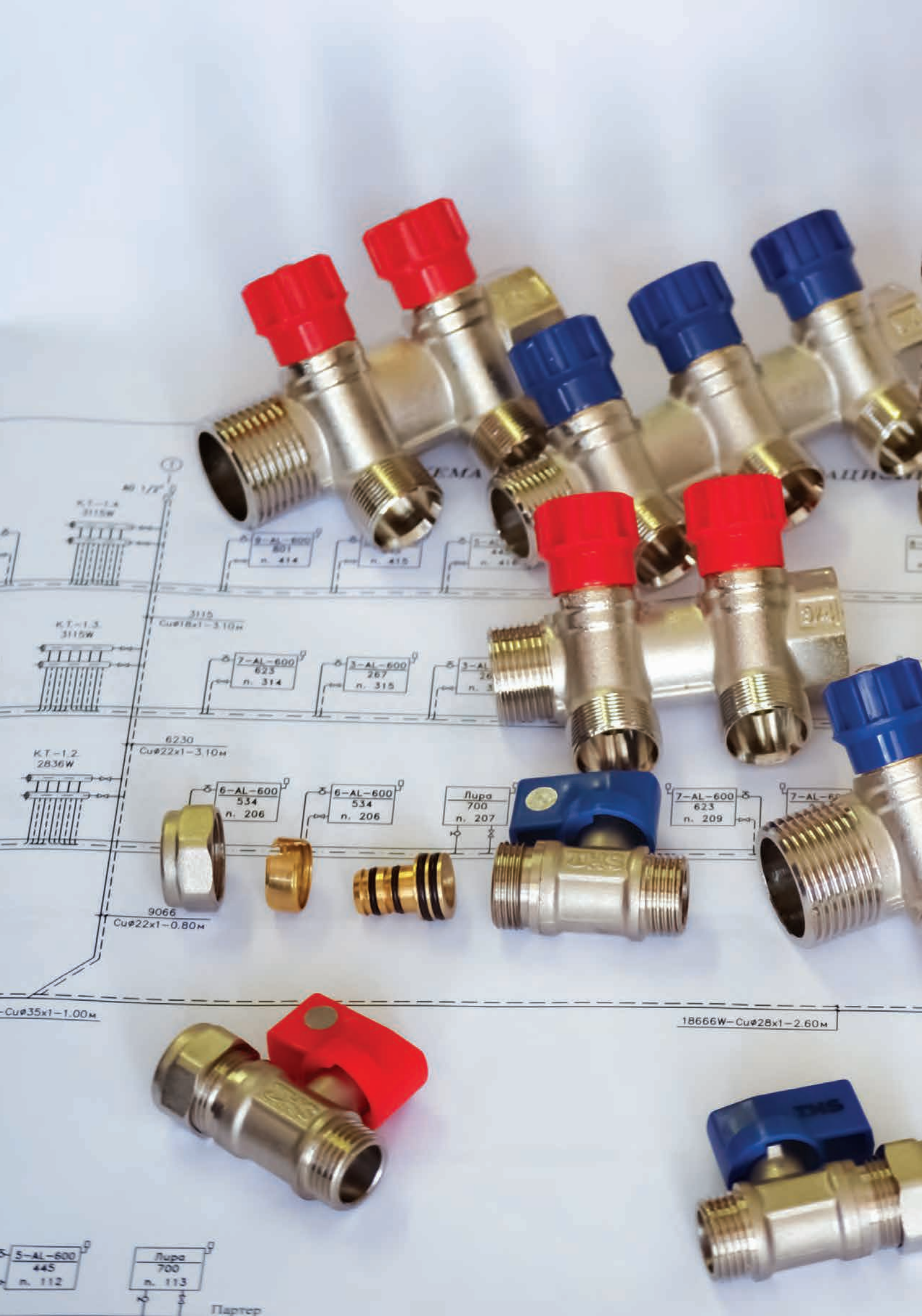



**ЩАМПОВАН КОЛЕКТОР 1" МЖ С ВЕНТИЛ И АДАПТОР Ø 16 mm
BRASS MANIFOLD 1" FM WITH ADAPTOR AND STOP VALVE Ø 16 mm**



Размер Dimension	Арт. № Item №	Баркод Barcode			
2 ОТВОРА/ 2 WAYS	241702	3800154009235	1/25		
3 ОТВОРА/ 3 WAYS	241703	3800154009242	1/20		
4 ОТВОРА/ 4 WAYS	241704	3800154009259	1/15		

**ЩАМПОВАН КОЛЕКТОР С ВЕНТИЛИ 3/4" 24 x 19
BRASS MANIFOLDS WITH STOP VALVES 3/4" 24 x 19**

**ЩАМПОВАН КОЛЕКТОР С ВЕНТИЛИ 1" 24 x 19
BRASS MANIFOLDS WITH STOP VALVES 1" 24 x 19**



Размер Dimension	Арт. № Item №	Баркод Barcode			
2 ОТВОРА/ 2 WAYS	6223	3800154023798	1/25		
3 ОТВОРА/ 3 WAYS	6224	3800154023804	1/20		
4 ОТВОРА/ 4 WAYS	6225	3800154023811	1/20		

Размер Dimension	Арт. № Item №	Баркод Barcode			
2 ОТВОРА/ 2 WAYS	241705	3800154023767	1/25		
3 ОТВОРА/ 3 WAYS	241706	3800154023774	1/20		
4 ОТВОРА/ 4 WAYS	241707	3800154023781	1/15		

ОТОПЛЕНИЕ HEATING

ЩАМПОВАН МЕСИНГОВ КОЛЕКТОР С ДЕБИТОМЕР МЖ 1", 24 x 19 BRASS MANIFOLDS WITH FLOW METER FM 1", 24 x 19

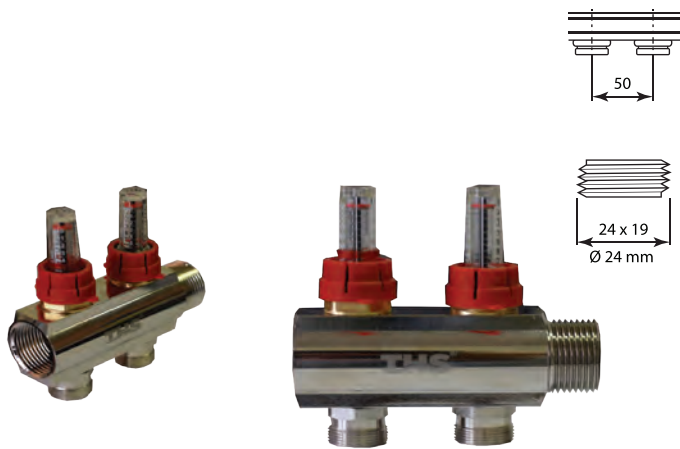

ЩАМПОВАН МЕСИНГОВ КОЛЕКТОР ЗА ЕЛ.ЗАДВИЖКА МЖ 1", 24 x 19 BRASS MANIFOLDS WITH HANDLE FM 1", 24 x 19

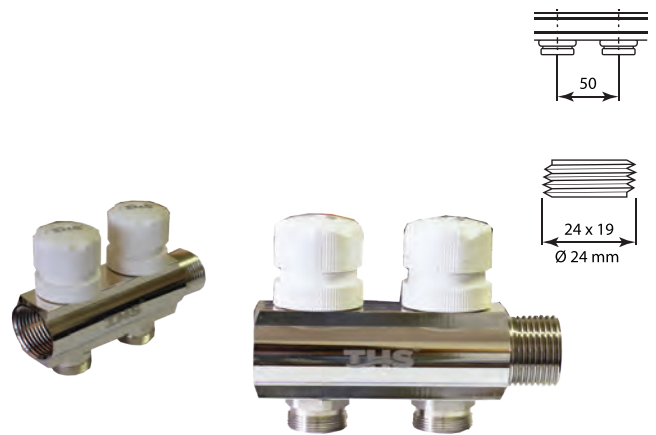

Размер Dimension	Арт. № Item №	Баркод Barcode		
2 ЛИНИИ/ 2 WAYS	7590	3800154029936	1/30	✓
3 ЛИНИИ/ 3 WAYS	7591	3800154029943	1/20	✓
4 ЛИНИИ/ 4 WAYS	7592	3800154029950	1/15	✓
5 ЛИНИИ/ 5 WAYS	7593	3800154029967	1/10	✓

Размер Dimension	Арт. № Item №	Баркод Barcode		
2 ЛИНИИ/ 2 WAYS	7594	3800154029974	1/30	✓
3 ЛИНИИ/ 3 WAYS	7595	3800154029981	1/20	✓
4 ЛИНИИ/ 4 WAYS	7596	3800154029998	1/15	✓
5 ЛИНИИ/ 5 WAYS	7597	3800154030000	1/10	✓

ЩАМПОВАН КОЛЕКТОР ЗА ПОДОВО ОТОПЛЕНИЕ СЕТ ЖЖ 1", 24 x 19 BRASS MANIFOLDS SET FF 1", 24 x 19

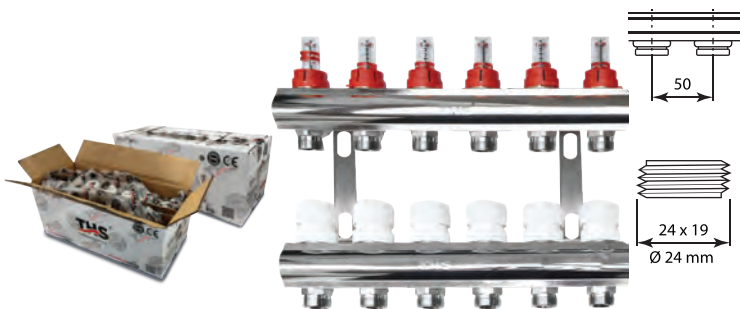

Размер Dimension	Арт. № Item №	Баркод Barcode		
6 ОТВОРА/ 6 WAYS	7887	3800154031496	1/1	✓
7 ОТВОРА/ 7 WAYS	7895	3800154031502	1/1	✓
8 ОТВОРА/ 8 WAYS	7899	3800154031519	1/1	✓
9 ОТВОРА/ 9 WAYS	7903	3800154031526	1/1	✓
10 ОТВОРА/ 10 WAYS	7905	3800154031533	1/1	✓

СКОБИ ЗА КОЛЕКТОРИ ЗА ПОДОВО ОТОПЛЕНИЕ КОМПЛЕКТ 2 БРОЯ BRACKETS FOR MANIFOLDS - SET OF 2 PCS

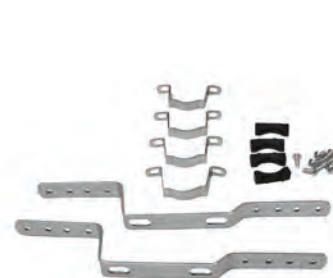

Размер Dimension	Арт. № Item №	Баркод Barcode		
	7598	3800154030017	1/40	✓



ЕЛЕКТРОЗАДВИЖКА 2 ПРОВОДНИКА КАБЕЛ 90 cm ELECTRIC THERMAL ACTUATOR CABLE 90 cm



- Електрозахранване 230V
Power supply 230V
- Ниска консумация на енергия 2W
Low power consumption 2W
- Лесни за инсталация
Easy to install
- Издържливост 110N
Endurance 110N
- Видим елемент, показващ отваряне или затваряне
Visible item showing opening or closing
- IP54



Размер Dimension	Арт. № Item №	Баркод Barcode			
M30X1.5-230V-IP54-110N	7599	3800154030024	1/100		

КОМПЛЕКТ ДЕБИТОМЕР И ЗАТВАРЯЩ МЕХАНИЗЪМ SET FOR FLOW METER AND CARTAGE



- Скала на потока на флуида:
от 0 до 5 литра/минута
Fluid low scale: 0 to 5 liters / minute
- Материал на горната част на дебитомера
- поликарбонат, издържащ до 110 ° C
**Upper lowmeter material - polycarbonate,
withstands up to 110 °C**
- Материал на основата - месинг
Base material - brass
- Материал на вътрешната
пружина - неръждаема стомана
Inner spring material - stainless steel

Размер Dimension	Арт. № Item №	Баркод Barcode			
	7908	3800154031540	1/200		

СМЕСИТЕЛНА ПОМПЕНА ГРУПА ЗА ПОДОВО ОТОПЛЕНИЕ MIXING PUMP UNIT

Technical data		Технически характеристики
The maximum temperature primary circuit	90°C	Максимална температура при първичния кръг
The maximum pressure	10bar	Максимално налягане
The maximum pressure drop primary circuit, other max.	1bar	Максимален спад на налягане в първичния кръг
Control range in the secondary circuit (range of regulation thermostat head)	20-60°C/ 30-70°C	Диапазон на управление във вторичната верига (обхват на регулираща термостатична глава)
Bypass the position of 0	10kw	Байпас на позиция 0
Bypass the position of 5	12.5kw	Байпас на позиция 5
Loss of pressure on the mixing valve (bypass the position of 0)	Kv3	Загуба на налягане смесителния клапан (избягвайте положението 0)
Loss of pressure on the mixing valve (bypass the position of 5)	Kvmax4.8	Загуба на налягане смесителния клапан (избягвайте положението 5)
Scale thermometer	0-120 °C	Скала на термометъра
The diameter of the connection to the high-temperature contour	1"	Присъединителна резба на подаващият колектор
The diameter of the connection to the low-temperature contour	1"	Присъединителна резба на връщащият колектор
Connection diameter and mounting length of circulation pump	1 1/4"	Присъединителни размери и монтажна дължина за циркуляционната помпа

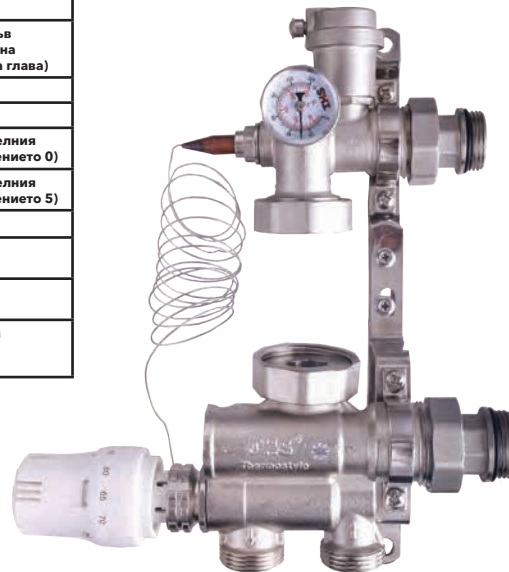

Размер Dimension	Арт. № Item №	Баркод Barcode			
1"	7589	3800154029844	1/5		

TMS
THERMOSTYLE



ОТОПЛЕНИЕ HEATING

ИЗПУСКАТЕЛ ЗА КОЛЕКТОР SEWAGE BRASS MINI BALL VALVE FOR MANIFOLD



Размер Dimension	Арт. № Item №	Баркод Barcode			
1/2"	4013	3800154009266			

КРАЕН ЕЛЕМЕНТ С ВКЛЮЧЕН АВТОМАТИЧЕН ОБЕЗВЪЗДУШИТЕЛ И КРАН ЗА ИЗТОЧВАНЕ BRASS END TEE WITH AUTOMATIC AIR VENT AND SEWAGE BRASS MINI VALVE



Размер Dimension	Арт. № Item №	Баркод Barcode			
1"	2428	3800154009273			
1 1/4"	2433	3800154009280			

КОЛЕКТОРНА РЕДУКЦИЯ МЖ BRASS BUSHING FOR MANIFOLD WITH RUBBER FM



Размер Dimension	Арт. № Item №	Баркод Barcode			
1" * 1/2"	2411	3800154023194			

КОЛЕКТОРНА ТАПА BRASS END CAP FOR MANIFOLD WITH RUBBER MALE



Размер Dimension	Арт. № Item №	Баркод Barcode			
1"	2412	3800154023200			

КРАЕН ЕЛЕМЕНТ ЗА КОЛЕКТОР BRASS END TEE FOR MANIFOLD FMF



Размер Dimension	Арт. № Item №	Баркод Barcode			
1/2"Ж * 3/4"М * 1/2"Ж	24761	3800154024153			
1/2"Ж * 3/4"Ж * 1/2"Ж	9043	3800154033254			
1/2"Ж * 1"М * 1/2"Ж	2476	380054009297			
1/2"Ж * 1"Ж * 1/2" Ж	9042	3800154033247			
1/2"Ж * 1 1/4"М * 1/2"Ж	6769	3800154028243			

АДАПТОР С ГАЙКА 24x19 FITTING PEX-AL-PEX 24x19



Размер Dimension	Арт. № Item №	Баркод Barcode			
24 x 19 x 16	241708	3800154023644			
24 x 19 x 20	5939	3800154023682			

СЪДИНИТЕЛ 24 x 19
CONNECTOR 24 x 19

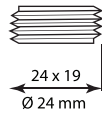

Размер Dimension	Арт. № Item №	Баркод Barcode			
24 x 19 x 24 x 19	6216	3800154024894	10/500		

НИПЕЛ МЪЖКИ 24x19
NIPPEL MALE 24 x19

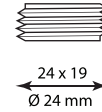

Размер Dimension	Арт. № Item №	Баркод Barcode			
24 x 19 x 1/2"	6214	3800154023613	10/500		
24 x 19 x 3/4"	6226	3800154037504	10/280		

НИПЕЛ ЖЕНСКИ 24 x 19
NIPPEL FEMALE 24 x19

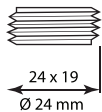

Размер Dimension	Арт. № Item №	Баркод Barcode			
24 x 19 x 1/2"	6215	3800154023620	10/450		
24 x 19 x 3/4"	6230	3800154037511	10/280		

КОЛЯНО МЪЖКО 24 x 19
ELBOW MALE 24 x19

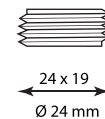

Размер Dimension	Арт. № Item №	Баркод Barcode			
24 x 19 x 1/2"	6217	3800154023637	10/250		
24 x 19 x 3/4"	9398	3800154037528	10/150		

КОЛЯНО ЖЕНСКО 24 x 19
ELBOW FEMALE 24 x19

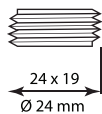

Размер Dimension	Арт. № Item №	Баркод Barcode			
24 x 19 x 1/2"	6218	3800154024924	10/250		
24 x 19 x 3/4"	9399	3800154037535	10/150		

КОЛЯНО 24 x19
ELBOW 24 x19

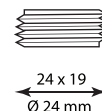

Размер Dimension	Арт. № Item №	Баркод Barcode			
24 x 19 x 24 x 19	6219	3800154023699	10/240		

**ОТОПЛЕНИЕ
HEATING**

**ТРОЙНИК МЪЖКИ 24 x 19
TEE BRASS MMM 24 x 19**

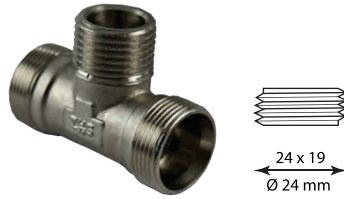

Размер Dimension	Арт. № Item №	Баркод Barcode			
24 x 19 x 1/2" x 24 x 19	6220	3800154024900	10/180		

**ТРОЙНИК ЖЕНСКИ 24 x 19
TEE FEMALE 24 x 19**



Размер Dimension	Арт. № Item №	Баркод Barcode			
24 x 19 x 1/2" x 24 x 19	6221	3800154024917	10/160		

**ТРОЙНИК 24 x 19
TEE 24 x 19**



Размер Dimension	Арт. № Item №	Баркод Barcode			
24x19 x 24x19 x 24x19	6222	3800154023705	10/180		

**ФИТИНГИ 24 x 19 - ЦЯЛОСТНО РЕШЕНИЕ С 12 ПРОДУКТА
FITTINGS 24 X 19 - COMPLETE SOLUTION WITH 12 ITEMS**

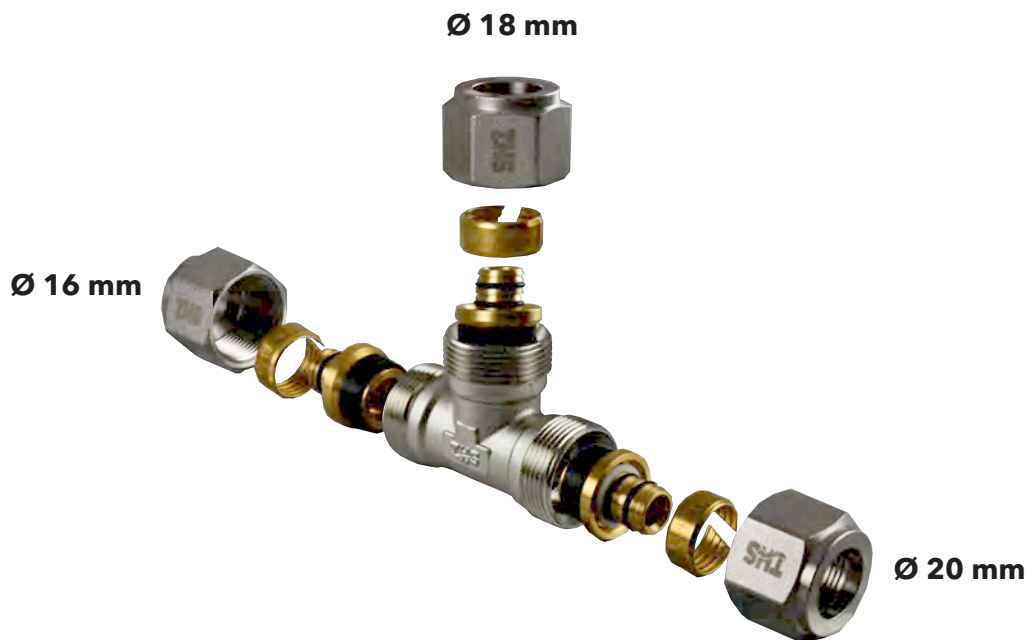

АДАПТОР ПРАВ МЪЖКИ
STRAIGHT FITTING FOR PEX AL PEX PIPE MALE



Размер Dimension	Арт. № Item №	Баркод Barcode			
Ø16 x 1/2"	2570	3800154009983	10/300	X	X
Ø16 x 3/4"	25104	3800154009990	10/240	X	X
Ø18 x 1/2"	2580	3800154010156	15/240	X	X
Ø20 x 1/2"	2590	3800154010262	10/210	X	X
Ø20 x 3/4"	2592	3800154010279	10/180	X	X

АДАПТОР ПРАВ ЖЕНСКИ
STRAIGHT FITTING FOR PEX AL PEX PIPE FEMALE



Размер Dimension	Арт. № Item №	Баркод Barcode			
Ø16 x 1/2"	2571	3800154010002	10/270	X	X
Ø16 x 3/4"	25105	3800154010019	10/210	X	X
Ø18 x 1/2"	2581	3800154010170	15/240	X	X
Ø20 x 1/2"	2593	3800154010286	10/180	X	X
Ø20 x 3/4"	2594	3800154010293	10/160	X	X

АДАПТОР ПРАВ РАВЕН
STRAIGHT FITTING FOR PEX AL PEX PIPE EQUAL



Размер Dimension	Арт. № Item №	Баркод Barcode			
Ø16 x Ø16	2572	3800154010026	10/240	X	X
Ø18 x Ø18	2582	3800154010194	10/180	X	X
Ø20 x Ø20	2595	3800154010309	10/150	X	X

АДАПТОР ЪГЛОВ МЪЖКИ
ELBOW FOR PEX AL PEX PIPE MALE



Размер Dimension	Арт. № Item №	Баркод Barcode			
Ø16 x 1/2"	2573	3800154010033	15/240	X	X
Ø18 x 1/2"	2583	3800154010200	10/180	X	X
Ø20 x 1/2"	2596	3800154010316	10/150	X	X
Ø20 x 3/4"	2597	3800154010323	10/140	X	X

АДАПТОР ЪГЛОВ ЖЕНСКИ
ELBOW FOR PEX AL PEX PIPE FEMALE



Размер Dimension	Арт. № Item №	Баркод Barcode			
Ø16 x 1/2"	2574	3800154010057	10/180	X	X
Ø20 x 1/2"	2598	3800154010330	10/130	X	X
Ø20 x 3/4"	2599	3800154010347	10/120	X	X

ОТОПЛЕНИЕ HEATING

АДАПТОР ЪГЛОВ РАВЕН ELBOW FOR PEX AL PEX PIPE EQUAL



Размер Dimension	Арт. № Item №	Баркод Barcode		
Ø16 x Ø16	2576	3800154010071	10/160	X
Ø18 x Ø18	2587	3800154010224	10/120	X
Ø20 x Ø20	25100	3800154010354	10/120	X

АДАПТОР ПЕТА ELBOW FOR WALL FOR PEX AL PEX PIPE



Размер Dimension	Арт. № Item №	Баркод Barcode		
Ø16 x 1/2"	2579	3800154010132	10/120	X

АДАПТОР ТРОЕН МЪЖКИ TEE FOR PEX AL PEX PIPE MALE



Размер Dimension	Арт. № Item №	Баркод Barcode		
Ø16 x 1/2" x Ø16	2546	3800154010088	10/160	X
Ø20 x 1/2" x Ø20	25111	3800154010361	10/140	X
Ø20 x 3/4" x Ø20	2548	3800154010378	5/100	X

АДАПТОР ТРОЕН ЖЕНСКИ TEE FOR PEX AL PEX PIPE FEMALE



Размер Dimension	Арт. № Item №	Баркод Barcode		
Ø16 x 1/2" x Ø16	2577	3800154010095	5/100	X
Ø20 x 1/2" x Ø20	25101	3800154010385	5/80	X
Ø20 x 3/4" x Ø20	25102	3800154010392	5/80	X

АДАПТОР ТРОЕН РАВЕН TEE FOR PEX AL PEX PIPE EQUAL



Размер Dimension	Арт. № Item №	Баркод Barcode		
Ø16 x Ø16 x Ø16	2578	3800154010125	10/100	X
Ø18 x Ø18 x Ø18	2589	3800154010255	5/80	X
Ø20 x Ø20 x Ø20	25103	3800154010408	10/70	X

АДАПТОР ТРОЕН РЕДУКТИВЕН TEE FOR PEX AL PEX PIPE EQUAL REDUCTIVE



Размер Dimension	Арт. № Item №	Баркод Barcode		
Ø16 x Ø16 x Ø20	2532	3800154010422	5/90	X
Ø16 x Ø20 x Ø16	2537	3800154010453	5/90	X
Ø20 x Ø16 x Ø20	2535	3800154010439	10/80	X
Ø16 x Ø20 x Ø20	2536	3800154010446	10/80	X



ПРЕС АДАПТОР ПРАВ МЪЖКИ
PRESS FITTING FOR PEX AL PEX STRAIGH MALE



Размер Dimension	Арт. № Item №	Баркод Barcode			
Ø 16 x 1/2"	25000	3800154010460	10/400	X	X
Ø16 x 3/4"	25002	3800154010477	20/400	X	X
Ø20 x 1/2"	25015	3800154010590	10/360	X	X
Ø20 x 3/4"	25016	3800154010606	10/270	X	X

ПРЕС АДАПТОР ПРАВ ЖЕНСКИ
PRESS FITTING FOR PEX AL PEX STRAIGH FEMALE



Размер Dimension	Арт. № Item №	Баркод Barcode			
Ø16 x 1/2"	25003	3800154010484	10/400	X	X
Ø16 x 3/4"	25004	3800154010491	15/400	X	X
Ø20 x 1/2"	25017	3800154010613	10/320	X	X
Ø20 x 3/4"	25018	3800154010620	10/240	X	X

ПРЕС АДАПТОР ПРАВ
PRESS FITTING FOR PEX AL PEX STRAIGH



Размер Dimension	Арт. № Item №	Баркод Barcode			
Ø16 x 16	25005	3800154010507	10/400	X	X
Ø20 x 20	25019	3800154010637	10/270	X	X

ПРЕС АДАПТОР ПРАВ РЕДУКТИВЕН
PRESS FITTING FOR PEX AL PEX STRAIGH REDUCING



Размер Dimension	Арт. № Item №	Баркод Barcode			
Ø20 x 16	25031	3800154029097	10/300		✓

ПРЕС АДАПТОР ЪГЛОВ МЪЖКИ
PRESS FITTING FOR PEX AL PEX ELBOW MALE



Размер Dimension	Арт. № Item №	Баркод Barcode			
Ø16 x 1/2"	25006	3800154010514	10/280	X	X
Ø16 x 3/4"	25007	3800154026782	10/320	X	X
Ø20 x 1/2"	25020	3800154010644	10/210	X	X
Ø20 x 3/4"	25021	3800154010651	10/180	X	X

ПРЕС АДАПТОР ЪГЛОВ ЖЕНСКИ
PRESS FITTING FOR PEX AL PEX ELBOW FEMALE



Размер Dimension	Арт. № Item №	Баркод Barcode			
Ø16 x 1/2"	25008	3800154010521	10/270		✓
Ø16 x 3/4"	25009	2000000250090	10/240		✓
Ø20 x 1/2"	25022	3800154010668	10/210		✓
Ø20 x 3/4"	25023	3800154010675	10/180		✓

ОТОПЛЕНИЕ HEATING

ПРЕС АДАПТОР ПРАВ С ХОЛЕНДРОВА ГАЙКА PRESS FITTING FOR PEX AL PEX STRAIGHT WITH NUT



Размер Dimension	Арт. № Item №	Баркод Barcode			
Ø16 x 1/2"	25013	3800154010583	10/240	X	X
Ø20 x 3/4"	25028	3800154010750	10/180	X	X

ПРЕС АДАПТОР ЪГЛОВ РЕДУКТИВЕН PRESS FITTING FOR PEX AL PEX ELBOW REDUCING



Размер Dimension	Арт. № Item №	Баркод Barcode			
Ø20 x 16	25032	3800154026799	10/240	X	X

ПРЕС АДАПТОР ПЕТА ЖЕНСКИ PRESS FITTING FOR PEX AL PEX WALL ELBOW FEMALE



Размер Dimension	Арт. № Item №	Баркод Barcode			
Ø16 x 1/2"	25014	3800154010576	10/160	X	X
Ø20 x 1/2"	25029	3800154010743	10/140	X	X

ПРЕС АДАПТОР ЪГЛОВ PRESS FITTING FOR PEX AL PEX ELBOW



Размер Dimension	Арт. № Item №	Баркод Barcode			
Ø16 x 1/2"	25010	3800154010538	10/300	X	X
Ø20 x 20	25024	3800154010682	10/200	X	X

ПРЕС АДАПТОР ТРОЙНИК МЪЖКИ PRESS FITTING FOR PEX AL PEX TEE MALE



Размер Dimension	Арт. № Item №	Баркод Barcode			
Ø16 x 1/2" x 16	25011	3800154010545	10/170	X	X
Ø20 x 1/2" x 20	25025	3800154010699	10/150	X	X
Ø20 x 3/4" x 20	25026	3800154010705	10/110	X	X

ПРЕС АДАПТОР ТРОЙНИК ЖЕНСКИ PRESS FITTING FOR PEX AL PEX TEE FEMALE



Размер Dimension	Арт. № Item №	Баркод Barcode			
Ø16 x 1/2" x 16	25012	3800154010552	10/170	X	X
Ø20 x 1/2" x 20	25037	3800154010712	10/120	X	X
Ø20 x 3/4" x 20	25038	3800154010729	10/100	X	X

ПРЕС АДАПТОР ТРОЙНИК PRESS FITTING FOR PEX AL PEX TEE



Размер Dimension	Арт. № Item №	Баркод Barcode			
Ø16 x 16 x 16	25030	3800154010569	10/180	X	X
Ø20 x 20 x 20	25027	3800154010736	10/20	X	X

ПРЕС АДАПТОР ТРОЙНИК РЕДУКТИВЕН PRESS FITTING FOR PEX AL PEX TEE REDUCING



Размер Dimension	Арт. № Item №	Баркод Barcode			
Ø20 x 16 x 20	25033	3800154026805	10/140	X	X
Ø20 x 20 x 16	25034	3800154026812	10/140	X	X
Ø20 x 16 x 16	25035	3800154026829	10/150	X	X
Ø16 x 20 x 16	25036	3800154026836	10/150	X	X

THS[®]
THERMOSTYLE



**МИНИ КРАН 24*19
BRASS MINI BALL VALVE 24*19**



Размер Dimension	Арт. № Item №	Баркод Barcode			
24x19 СИНЯ РЪКОХВАТКА 24x19 BLUE HANDLE	6775	3800154028427	30/360		
24x19 ЧЕРВЕНА РЪКОХВАТКА 24x19 RED HANDLE	6776	3800154028434	30/360		

**МИНИ КРАН С АДАПТОР С ВЪНШНА РЕЗБА
BRASS MINI BALL VALVE FOR PEX AL PEX PIPE MALE**



Размер Dimension	Арт. № Item №	Баркод Barcode			
Ø 16x1/2" СИНЯ РЪКОХВАТКА/ BLUE HANDLE	2563	3800154009907	20/240		
Ø 16x1/2" ЧЕРВЕНА РЪКОХВАТКА/RED HANDLE	25631	3800154009914	20/240		
Ø 20x1/2" СИНЯ РЪКОХВАТКА/ BLUE HANDLE	2569	3800154009969	15/180		
Ø 20x1/2" ЧЕРВЕНА РЪКОХВАТКА/RED HANDLE	25691	3800154009976	15/180		

**МИНИ КРАН С АДАПТОР С ВЪТРЕШНА РЕЗБА
BRASS MINI BALL VALVE FOR PEX AL PEX PIPE FEMALE**



Размер Dimension	Арт. № Item №	Баркод Barcode			
Ø 16x1/2" СИНЯ РЪКОХВАТКА/ BLUE HANDLE	2564	3800154009921	24/240		
Ø 16x1/2" ЧЕРВЕНА РЪКОХВАТКА/ RED HANDLE	25641	3800154009938	24/240		

**МИНИ КРАН С АДАПТОР РАВЕН
MINI BRASS BALL VALVE CHROME PLATED FF**



Размер Dimension	Арт. № Item №	Баркод Barcode			
Ø 16xØ 16 СИНЯ РЪКОХВАТКА/ BLUE HANDLE	2565	3800154009945	15/180		
Ø 16xØ 16 ЧЕРВЕНА РЪКОХВАТКА/ RED HANDLE	25651	3800154009952	15/180		



ОТОПЛЕНИЕ HEATING

КОЛЕКТОРНА КУТИЯ ЗА ВГРАЖДАНЕ INNER BOX FOR MANIFOLDS



Размер Dimension	Арт. № Item №	Баркод Barcode			
450/400/100	2633	3800154012433	1/1		
450/500/100	2634	3800154012440	1/1		
450/600/100	2635	3800154012457	1/1		
450/700/100	2639	3800154012464	1/1		
450/800/100	2636	3800154012471	1/1		
450/1200/100	7565	3800154029691	1/1		

КОЛЕКТОРНА КУТИЯ ЗА ВЪНШЕН МОНТАЖ OUTER BOX FOR MANIFOLDS



Размер Dimension	Арт. № Item №	Баркод Barcode			
450/400/110	2644	3800154012488	1/1		
450/500/110	2643	3800154012495	1/1		
450/600/110	2641	3800154012501	1/1		
450/700/110	2640	3800154012518	1/1		
450/800/110	2645	3800154012525	1/1		
450/1200/110	7566	3800154029707	1/1		

КОЛЕКТОРНА КУТИЯ ЗА ВЪНШЕН МОНТАЖ С КЛЮЧ OUTER BOX FOR MANIFOLDS WITH LOCKER



Размер Dimension	Арт. № Item №	Баркод Barcode			
450/400/120	26441	3800154028250	1/1		
450/500/120	26431	3800154028267	1/1		
450/600/120	26411	3800154028274	1/1		
450/700/120	26401	3800154028281	1/1		
450/800/120	26451	3800154028298	1/1		
450/1200/120	7615	3800154030420	1/1		

W - ширина
H - височина
D - дълбочина

W - width
H - height
D - depth



ПОЖАРНО ТАБЛО ЗА ВГРАЖДАНЕ CABINET FOR FIRE VALVES



Размер Dimension	Арт. № Item №	Баркод Barcode			
БЯЛ/WHITE	400006	3800154023477	1/1		
ЧЕРВЕН/RED	4000061	3800154029141	1/1		

ПОЖАРНО ТАБЛО ЗА ВЪНШЕН МОНТАЖ CABINET FOR FIRE VALVES FOR OUTDOOR INSTALLATION



Цвет Color	Арт. № Item №	Баркод Barcode			
БЯЛ/WHITE	40007	3800154029127	1/1		
ЧЕРВЕН/RED	400071	3800154029134	1/1		

**ПОМПА ЗА ПАРНО КОМПЛЕКТ С ХОЛЕНДРИ ЕНЕРГИЕН КЛАС А
ENERGY SAVING CIRCULATING PUMPS**

Шумоизолация/
Sound insulation

Функция / Function
AUTO ADAPTIVE

Energy

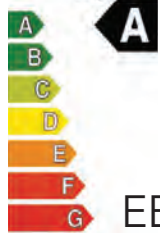

EEI ≤ 0.20



Размер Dimension	Арт. № Item №	Баркод Barcode			
25/4 -22W	269101	3800154016462	1/8	<input checked="" type="checkbox"/>	<input checked="" type="checkbox"/>
25/6-45W	269111	3800154016479	1/8	<input checked="" type="checkbox"/>	<input checked="" type="checkbox"/>
32/6-45W	269121	3800154016486	1/8	<input checked="" type="checkbox"/>	<input checked="" type="checkbox"/>

**ПОМПА ЗА ПАРНО КОМПЛЕКТ С ХОЛЕНДРИ ЕНЕРГИЕН КЛАС А
ENERGY SAVING CIRCULATING PUMP**

Energy

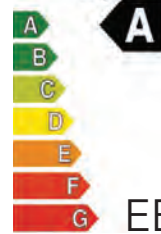

EEI ≤ 0.20



Размер Dimension	Арт. № Item №	Баркод Barcode			
25/4	7756	3800154031465	1/8	<input checked="" type="checkbox"/>	<input checked="" type="checkbox"/>
25/6	7757	3800154017025	1/8	<input checked="" type="checkbox"/>	<input checked="" type="checkbox"/>
32/6	7758	3800154031472	1/8	<input checked="" type="checkbox"/>	<input checked="" type="checkbox"/>

**ПОМПА ЗА ПАРНО КОМПЛЕКТ С ХОЛЕНДРИ
CIRCULATING PUMPS**



Размер Dimension	Арт. № Item №	Баркод Barcode			
25/40-38W-53W-72W-220V-50HZ	26910	3800154015540	1/8	<input checked="" type="checkbox"/>	<input checked="" type="checkbox"/>
25/60-46W-67W-93W-220V-50HZ	26911	3800154015557	1/8	<input checked="" type="checkbox"/>	<input checked="" type="checkbox"/>
32/60-46W-67W-93W-220V-50HZ	26912	3800154015564	1/8	<input checked="" type="checkbox"/>	<input checked="" type="checkbox"/>
32/80-150W-210W-270W-220V-50HZ	26913	3800154016981	1/8	<input checked="" type="checkbox"/>	<input checked="" type="checkbox"/>

**КИТ ХОЛЕНДЪР ЗА ПОМПА
UNION WITH RUBBER FOR CIRCULATION PUMP**



Размер Dimension	Арт. № Item №	Баркод Barcode			
25 - 1" * 1 1/2"	30302	3800154017018	1/140	<input checked="" type="checkbox"/>	<input checked="" type="checkbox"/>
32 - 1 1/4" * 2"	30303	3800154017025	1/80	<input checked="" type="checkbox"/>	<input checked="" type="checkbox"/>

Помпи с арт.№: 26910, 26911, 26912, 26913 се продават само извън ЕС
The pumps with codes 26910, 26911, 26912, 26913 are available for sales only out of EU

ОТОПЛЕНИЕ HEATING

МАНОМЕТЪР АКСИАЛЕН MANOMETER AXIAL



Размер Dimension	Арт. № Item №	Баркод Barcode			
0 - 6 bar. Ø 60	2448	3800154009556	1/100	<input checked="" type="checkbox"/>	<input checked="" type="checkbox"/>
0 - 10 bar. Ø 60	2439	3800154009563	1/100	<input checked="" type="checkbox"/>	<input checked="" type="checkbox"/>

МАНОМЕТЪР РАДИАЛЕН MANOMETER RADIAL



Размер Dimension	Арт. № Item №	Баркод Barcode			
0 - 6 bar. Ø 60	2427	3800154009570	1/100	<input checked="" type="checkbox"/>	<input checked="" type="checkbox"/>
0 - 10 bar. Ø 60	2426	3800154009587	1/100	<input checked="" type="checkbox"/>	<input checked="" type="checkbox"/>

ТЕРМОМАНОМЕТЪР АКСИАЛЕН Ø 80 1/2" TERMOMANOMETER AXIAL Ø 80 1/2"



Размер Dimension	Арт. № Item №	Баркод Barcode			
0-10 bar. 20°-120°	2475	3800154009679	1/80	<input checked="" type="checkbox"/>	<input checked="" type="checkbox"/>

ТЕРМОМАНОМЕТЪР РАДИАЛЕН Ø 80 1/2" TERMOMANOMETER RADIAL Ø 80 1/2"



Размер Dimension	Арт. № Item №	Баркод Barcode			
0-10 bar. 20°-120°	2469	3800154009686	1/100	<input checked="" type="checkbox"/>	<input checked="" type="checkbox"/>

ТЕРМОМЕТЪР С МЕТАЛЕН КОРПУС THERMOMETER



Размер Dimension	Арт. № Item №	Баркод Barcode			
0° - 120° Ø 38	2474	3800154009648	1/192	<input checked="" type="checkbox"/>	<input checked="" type="checkbox"/>

ТЕРМОМЕТЪР МЕТАЛЕН КОРПУС 0°-120° THERMOMETER 0°-120°



Размер Dimension	Арт. № Item №	Баркод Barcode			
Ø 40 1/2"	7754	3800154031458	1/100	<input checked="" type="checkbox"/>	<input checked="" type="checkbox"/>
Ø 40 1/4"	7753	3800154031441	1/100	<input checked="" type="checkbox"/>	<input checked="" type="checkbox"/>

ПРЕДПАЗЕН ВЕНТИЛ МЕСИНГ BRASS SAFE VALVE



Размер Dimension	Арт. № Item №	Баркод Barcode			
1/2" 2.5 bar	24170	3800154009525	1/200	<input checked="" type="checkbox"/>	<input checked="" type="checkbox"/>
1/2" 3 bar	24171	3800154009532	1/200	<input checked="" type="checkbox"/>	<input checked="" type="checkbox"/>
1/2" 6 bar	24172	3800154009549	1/200	<input checked="" type="checkbox"/>	<input checked="" type="checkbox"/>

МЕСИНГОВ НАКРАЙНИК BRASS FITTING

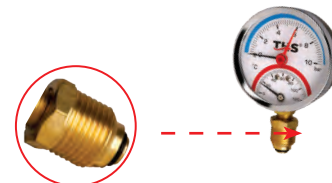

Размер Dimension	Арт. № Item №	Баркод Barcode			
1/2"М x 1/4"Ж 1/2"М x 1/4"Ф	8481	3800154032554	1/1000	<input checked="" type="checkbox"/>	<input checked="" type="checkbox"/>

РАЗШИРИТЕЛЕН СЪД ОТВОРЕНА СИСТЕМА ХОРИЗОНТАЛЕН ЛЯВ EXTENSION TANK HORIZONTAL LEFT



Размер Dimension	Арт. № Item №	Баркод Barcode			
30 ЛИТРА/LITERS	32013	3800154012280	1/1		
50 ЛИТРА/LITERS	32014	3800154012297	1/1		

РАЗШИРИТЕЛЕН СЪД ОТВОРЕНА СИСТЕМА ХОРИЗОНТАЛЕН ДЕСЕН EXTENSION TANK HORIZONTAL RIGHT



Размер Dimension	Арт. № Item №	Баркод Barcode			
30 ЛИТРА/LITERS	320131	3800154027017	1/1		
50 ЛИТРА/LITERS	320141	3800154027024	1/1		

РАЗШИРИТЕЛЕН СЪД ОТВОРЕНА СИСТЕМА ВЕРТИКАЛЕН ЛЯВ EXTENSION TANK VERTICAL LEFT



Размер Dimension	Арт. № Item №	Баркод Barcode			
30 ЛИТРА/LITERS	32003	3800154012334	1/1		
50 ЛИТРА/LITERS	32004	3800154012341	1/1		

РАЗШИРИТЕЛЕН СЪД ОТВОРЕНА СИСТЕМА ВЕРТИКАЛЕН ДЕСЕН EXTENSION TANK VERTICAL RIGHT



Размер Dimension	Арт. № Item №	Баркод Barcode			
30 ЛИТРА/LITERS	320031	3800154027055	1/1		
50 ЛИТРА/LITERS	320041	3800154027062	1/1		

РАЗШИРИТЕЛЕН СЪД ЗА ОТВОРЕНА СИСТЕМА УНИВЕРСАЛЕН/КУБИЧЕН EXTENSION TANK ALL-PURPOSE







Размер Dimension	Арт. № Item №	Баркод Barcode			
8 ЛИТРА/LITERS	5640	3800154027079	1/1		
13 ЛИТРА/LITERS	5641	3800154027086	1/1		
17 ЛИТРА/LITERS	5642	3800154027093	1/1		
23 ЛИТРА/LITERS	5643	3800154027109	1/1		
33 ЛИТРА/LITERS	5644	3800154027116	1/1		

ОТОПЛЕНИЕ
HEATING

РАЗШИРИТЕЛЕН СЪД ОТВОРЕНА СИСТЕМА ХОРИЗОНТАЛЕН
EXTENSION TANK HORIZONTAL



Размер Dimension	Арт. № Item №	Баркод Barcode			
8 ЛИТРА/LITERS	10283	3800154041259	1/1		
12 ЛИТРА/LITERS	10284	3800154041266	1/1		
18 ЛИТРА/LITERS	10285	3800154041273	1/1		

РАЗШИРИТЕЛЕН СЪД ОТВОРЕНА СИСТЕМА ВЕРТИКАЛЕН
EXTENSION TANK VERTICAL



Размер Dimension	Арт. № Item №	Баркод Barcode			
8 ЛИТРА/LITERS	10286	3800154041280	1/1		
12 ЛИТРА/LITERS	10287	3800154041297	1/1		
18 ЛИТРА/LITERS	10288	3800154041303	1/1		



РАЗШИРИТЕЛЕН СЪД ЗАТВОРЕНА СИСТЕМА МЕМБРАНЕН
PRESSURE CONTROL TANKS



Размер Dimension	Арт. № Item №	Баркод Barcode			
5 ЛИТРА/LITERS	5001	3800154012358	1/1		
8 ЛИТРА/LITERS	5002	3800154012365	1/1		
12 ЛИТРА/LITERS	5003	3800154012372	1/1		
19 ЛИТРА/LITERS	5004	3800154012389	1/1		
24 ЛИТРА/LITERS	5005	3800154012396	1/1		
36 ЛИТРА/LITERS	5006	3800154012402	1/1		

РАЗШИРИТЕЛЕН СЪД ЗАТВОРЕНА СИСТЕМА МЕМБРАНЕН С ПОДПОРА
PRESSURE CONTROL TANKS WITH LEGS



Размер Dimension	Арт. № Item №	Баркод Barcode			
50 ЛИТРА/LITERS	5007	3800154012419	1/1		

РАЗШИРИТЕЛЕН СЪД ЗАТВОРЕНА СИСТЕМА МЕМБРАНЕН С ПОДПОРА С
ВГРАДЕН МАНОМЕТЪР
PRESSURE CONTROL TANKS WITH LEGS AND INBUILT MANOMETER



Размер Dimension	Арт. № Item №	Баркод Barcode			
80 ЛИТРА/LITERS	5008	3800154012426	1/1		
100 ЛИТРА/LITERS	5009	3800154027123	1/1		
150 ЛИТРА/LITERS	5010	3800154027130	1/1		

КАШОН / OUTER CARTON



ВЪТРЕШЕН КАШОН / INNER BOX



ЕДИНИЧНИ ОПАКОВКИ / SINGLE PACKAGING

ПЛИКЧЕ

POLY BAG

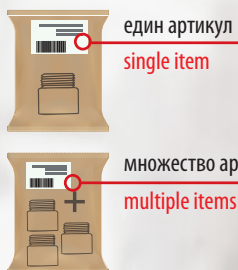

един артикул

single item

множество арт.

multiple items



ЕВРО ОТВОР

EURO HOLE

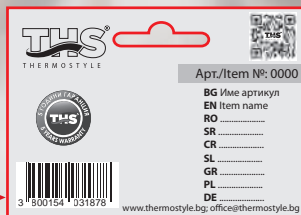

ТАГ

TAG



БЛИСТЕР

BLISTER

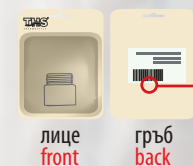

лице

front

гръб

back



КУТИЯ

BOX



кутия с евро отвор

box with euro hole

кутия

box



ЛЕГЕНДА / LEGEND:



БРОЙ В ОПАКОВКА / QTY in PACKAGE



БРОЙ В КАШОН / QTY in OUTER CARTON



НАЛИЧЕН БАРКОД НА ВСЕКИ ОТДЕЛЕН АРТИКУЛ / BARCODE FOR EACH SEPARATE ITEM
 ДА ✓ НЕ ✗ YES ✓ NO ✗



office@thermostyle.bg

www.thermostyle.bg

